

AECOM

locality  
the power of community

# Wilsden Design Codes

Wilsden Neighbourhood Plan

December 2022

Delivering a better world



## Quality information

Prepared by	Check by	Approved by
Elliot Joddrell, Urban Designer	Lee Wood, Regional Director	Becky Mather, Regional Director

## Revision History

Issue no.	Issue date	Details	Issued by	Position
01	20/08/21	1st Draft issued to NPSG	Elliot Joddrell	Urban Designer
02	29/09/21	2nd Draft reflecting comments received from Peter Allison on 11/09/21	Elliot Joddrell	Urban Designer
03	29/10/21	Final Draft reflecting comments received from the NPSG on 10/10/21	Elliot Joddrell	Urban Designer
04	22/11/21	Final document reflecting comments received in sign-off meeting held with NPSG on 10/11/21	Elliot Joddrell	Urban Designer
05	12/01/22	Final document following internal review	Elliot Joddrell	Urban Designer
06	19/12/22	Updated document following Local Authority comments	Elliot Joddrell	Urban Designer

This document has been prepared by AECOM Limited ("AECOM") in accordance with its contract with Locality (the "Client") and in accordance with generally accepted consultancy principles, the budget for fees and the terms of reference agreed between AECOM and the Client. Any information provided by third parties and referred to herein has not been checked or verified by AECOM, unless otherwise expressly stated in the document. AECOM shall have no liability to any third party that makes use of or relies upon this document.

# Contents

<b>1</b>	<b>1. Introduction</b>	<b>5</b>
	1.1 Background	5
	1.2 Objective	5
	1.3 Methodology	5
	1.4 Document Structure	6
	1.5 Study Area	6
	1.6 Planning Context	6
<b>2</b>	<b>2. Place Assessment</b>	<b>12</b>
	2.1 Historic Evolution & Heritage	12
	2.2 Landscape	14
	2.3 Route Hierarchy	17
	2.4 Village & Open Space Structure	19
	2.5 Sense of Place & Wayfinding	21
<b>3</b>	<b>3. Local Character</b>	<b>26</b>
	3.1 Photographic Analysis and Observations	26
	3.2 Key Findings and Opportunities	36
<b>4</b>	<b>4. Character Areas and Design Codes</b>	<b>38</b>
	4.1 The Codes	38
	4.2 When to Use the Codes	38
	4.3 Defining Areas for Coding	39
	4.4 Code 1 - Sustainability and Climate Change	46
	4.5 Code 2 - Landscape, Views and the Settlement Edge	48
	4.6 Code 3 - Building Design	52
	4.7 Code 4 - Parking, Gardens and Boundary Treatments	55
	4.8 Code 5 - Privacy, Space and Natural Surveillance	58
<b>5</b>	<b>5. Site Responses</b>	<b>60</b>
	5.1 Possible development site at Crooke Lane (within settlement area)	61
	5.2 An edge of settlement site scenario	62
<b>6</b>	<b>6. Next Steps</b>	<b>63</b>



A photograph of a traditional stone building with a red door and a chimney, set in a lush, green environment with a pond in the foreground. A large green circle is overlaid on the image, containing the text 'Introduction' and '01'.

**Introduction**

# 01



# 1. Introduction

## 1.1 Background

The village of Wilsden in Bradford has established a Neighbourhood Plan Steering Group (NPSG) in order to shape and influence development within their area. The NPSG have approved their Draft Neighbourhood Plan.

Through the Department for Levelling Up, Housing and Communities (DLUCH) Neighbourhood Planning Programme led by Locality, AECOM has been commissioned to provide design support to Wilsden NPSG to prepare this Design Code document which will form part of the evidence base for their Neighbourhood Plan.

## 1.2 Objective

The purpose of this document is to provide an appreciation of Wilsden Parish's existing character in order to create a set of design codes which will apply to any future housing development. This will help to ensure that as any new development comes forward, it responds to its context and supports and enhances the quality of the village's existing character.

## 1.3 Methodology

The process that was undertaken to produce this Design Code document is as follows:

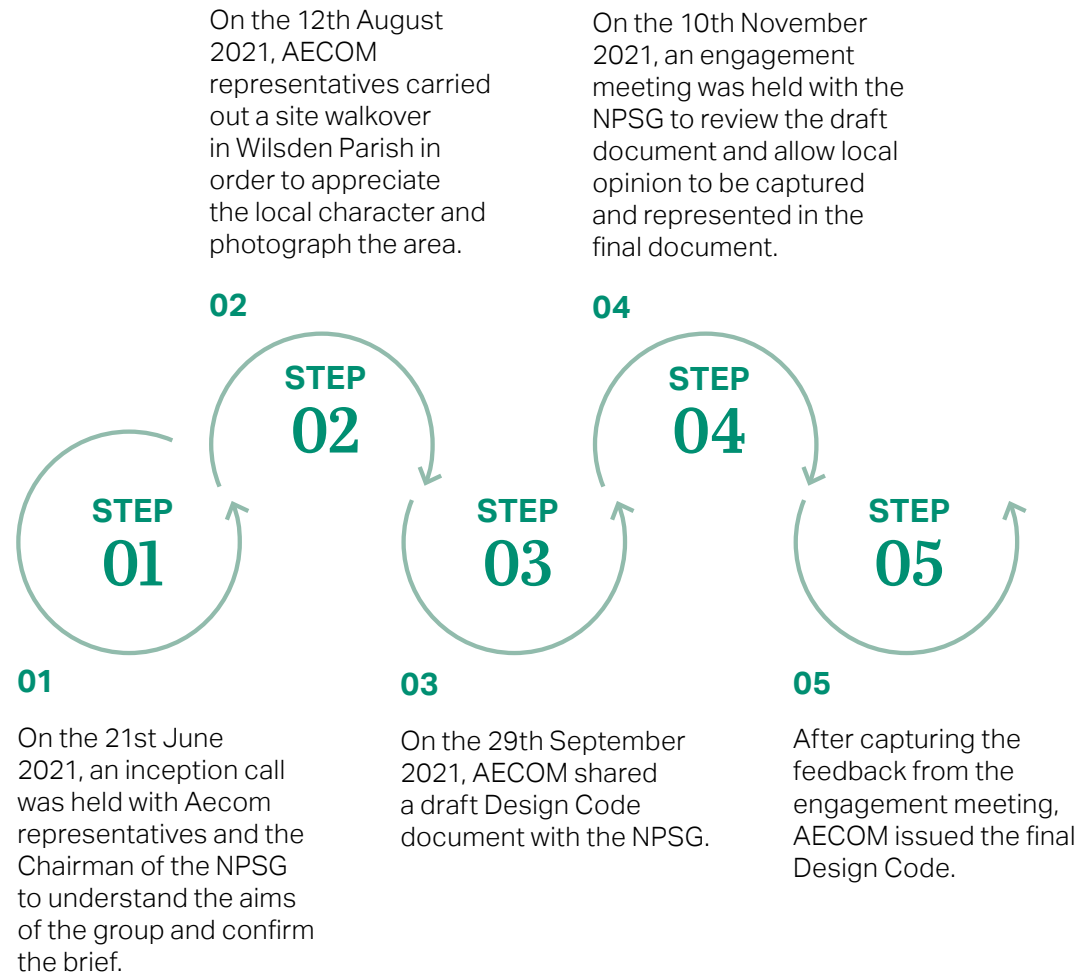



## 1.4 Document Structure

This Design Code document comprises of the following six sections:

### 01 Introduction

Outlining the background, purpose, process, study area and design code document structure as well as reviewing the planning policy context for development in Wilsden Parish.

### 02 Place Assessment

Provides an appreciation of physical influences which will be used to help inform the design codes

### 03 Local Character

A more focussed understanding of Wilsden Parish's built and natural landscape character is provided by undertaking a photographic survey to analyse key characteristics.

### 04 Character Areas and Design Codes

Character Areas are defined and the design codes to be applied to future housing developments in the Neighbourhood Plan area are established.

### 05 Site Responses

Design codes are applied to site scenarios within Wilsden using high level design principles diagrams.

### 06 Next Steps

Provides guidance on the next steps for the NPSG and potential future developers.

## 1.5 Study Area

The Neighbourhood Plan area comprises the village of Wilsden, neighbouring Harecroft and the surrounding rural context. In order to influence the design of future housing around the main settlement area, this document will predominantly be focussed on the extent of the built-up area and its more immediate surroundings.

## 1.6 Planning Context

Wilsden Parish sits within the Metropolitan District of Bradford in West Yorkshire. The following planning documents were reviewed to understand the policy context which will influence this design code document.

### **Draft Bradford District Local Plan - Preferred Options (Regulation 18) February 2021**

The Draft Local Plan identifies that allocations will be required within Wilsden with the potential to deliver 130 dwellings

### **Bradford Local Plan: Core Strategy Development Plan Document (DPD) - Adopted July 2017**

The Core Strategy (DPD) is central to the Bradford District's Local Plan as it stipulates the spatial and strategic vision for the area. The following policies of the current adopted Core Strategy are the documents most relevant for the Wilsden Neighbourhood Plan:

### **Policy SC4 Hierarchy of Settlements**

The Bradford District settlement hierarchy defines Wilsden as a 'Local Service Centre'. The policy states that development within such settlements should emphasise smaller scale development that comprises both market and affordable housing, along with the 'protection and enhancement' of their centres 'as attractive and vibrant places



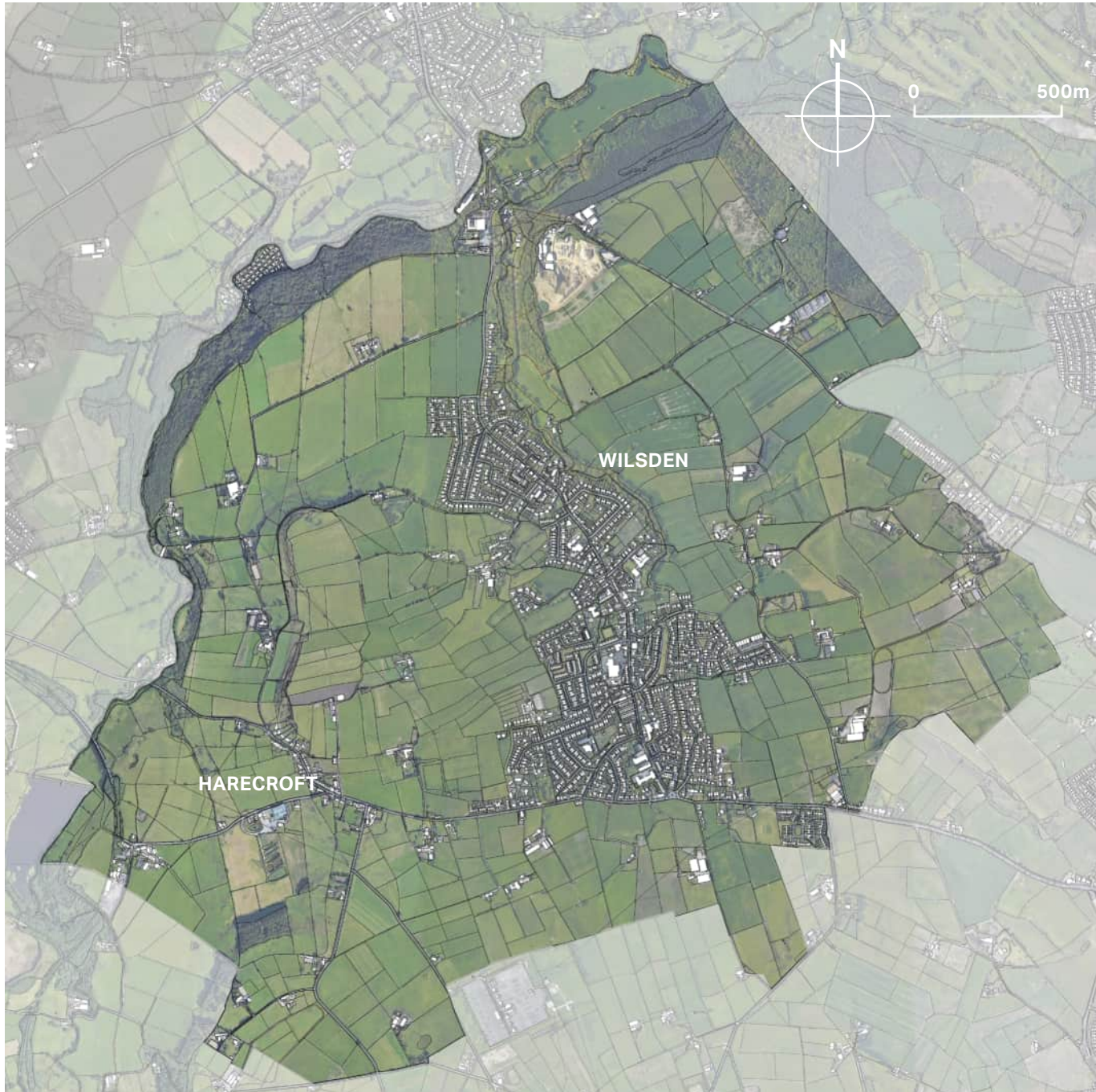

Map showing the neighbourhood plan area of Wilsden

and communities'. This can be achieved by ensuring any new development upholds and enhances local amenity and by achieving high standards of design that contributes to the settlements diversity and character.

### **Policy SC6 Green Infrastructure**

The policy states the opportunities that the watercourses of the South Pennine Moors present in enhancing the living landscape for both people and wildlife. This includes taking measures to address the future needs of flooding alleviation, water management, carbon capture and recreation.

### **Policy SC7 Green Belt**

With much of the Wilsden Neighbourhood Plan boundary falling within designated Green Belt land, any development proposals within such areas must be in accordance with relevant national policy.



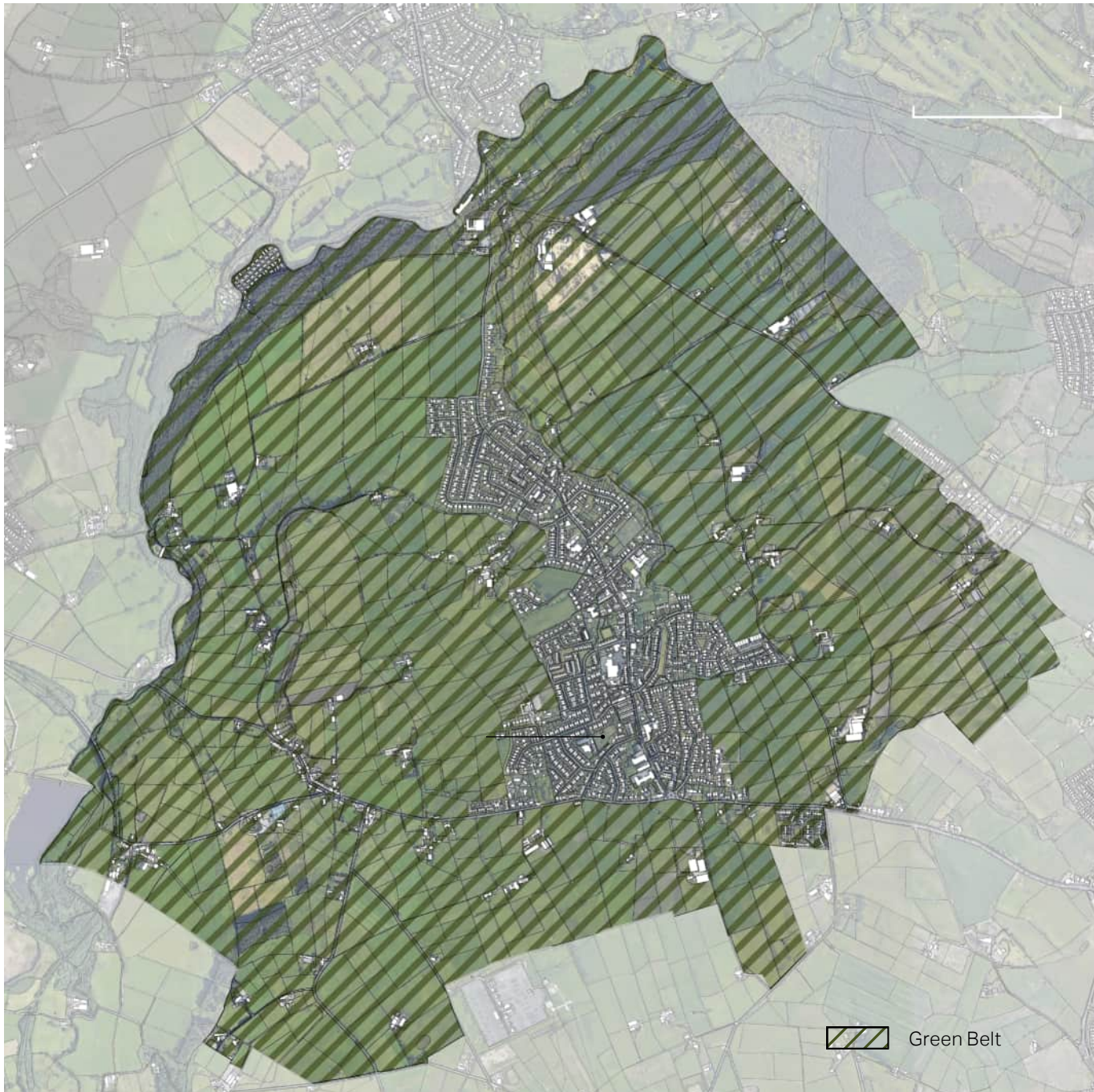

Map showing the Green Belt

**Policy SC8 Protecting the South Pennine Moors SPA and the South Pennine Moors SAC and their zone of influence**

The South Pennine Moors includes numerous areas that are classified as either a Special Protection Area (SPA) or Special Area of Conservation (SAC). Subject to the tests of Article 6(4) of the Habitats Directive, development that threatens the integrity of the SPA or SAC, which cannot be effectively mitigated, will not be supported. The Wilsden Neighbourhood Plan falls within the least restrictive of three zones (Zone C) since it is up to 7km from the nearest SPA/SAC. Residential developments that result in a net increase of one or more dwellings should therefore consider the recreational pressure on nearby SPA/SAC's. Development will be supported where such pressures are mitigated via the delivery of additional greenspace/recreational spaces.

**Policy PN1 South Pennine Towns and Villages**

The policy states Wilsden will accommodate 200 residential dwellings in the period up to 2030. Since 2013, the start of the Core Strategy more than 105 dwellings have been completed requiring up to 95



additional homes to be delivered. These will be mainly delivered within the existing settlement boundary with the remainder being permitted across green belt. Such development will be supported where appropriate community facilities are included (i.e. healthcare, open space and recreational facilities).

### **Policy TR3 Public Transport, Cycling and Walking**

This policy presides over the prioritisation for sustainable transport through the safeguarding and improvement of public transport, cycling and walking infrastructure. The policy requires the layout of any development proposal to incorporate sufficient cycling and walking infrastructure that connects to surrounding existing transport networks.

### **Policy HO5 Density of Housing Schemes**

The policy states a minimum requirement of 30 dwellings per hectare. It is proposed to raise this figure to 35 dph within the emerging Local Plan. Development will be supported where housing layouts reflect the nature of the site as well as the local demand for housing typologies and sizes.

### **Policy HO9 Housing Quality**

Any new housing development should be of high quality and achieve good design. Developments demonstrating strong sustainability credentials and construction standards will be favoured. Larger housing schemes should aim to be accessible and easily adaptable to support the changing needs of homeowners throughout the ownership life cycle.

### **Policy HO11 Affordable Housing**

The policy requires an affordable housing quota of 20% on developments of 11 units or more in settlements the size of Wilsden. It is proposed to reduce this figure to 10 dwellings within the emerging Local Plan. The preferred tenure mix for such housing will be 70:30 social/affordable rent. All affordable housing provision must be indistinguishable from and integrated with the proposals market housing.

### **Policy EN3 Historic Environment**

This policy emphasises the need to preserve, protect, and enhance the character, appearance, and historic value of the districts heritage assets. It requires all new development to conserve and uphold the districts distinctive character by responding sensitively to any heritage

assets within or nearby to any development proposal.

### **Policy EN4 Landscape**

The policy cites Wilsden as being where development decisions and proposals should make a positive contribution towards the conservation, management and enhancement of its characterful landscape. Any development should follow the approach set out in the Landscape Character Assessment Supplementary Planning Document (SPD). The following criteria will be used to assess whether any new development can be supported:

‘The potential for adverse landscape/visual impacts’

‘The importance of cultural associations, historic elements in the landscape and setting of settlements and heritage assets’

‘The opportunity to contribute towards positive restoration of landscapes, particularly in the urban fringe, and also achieve greater habitat connectivity’

### **Sustainable Design Guide SPD (November 2006)**

This guidance outlines how developers can adopt sustainable design principles within their proposals. Adopting such methods is



in the interest of both developers and the Bradford District's inhabitants. For example, the document suggests approaching development in a flexible manner by creating buildings/spaces that can be adapted to meet changing needs/demands over time. It's also suggested renewable energy sources and environmentally friendly materials should be used wherever financially and logistically viable. Where evidence of sustainable construction practices/contractors are shown, development will be supported, due to the myriad of adverse impacts the construction process has on surrounding landscapes.

### **Landscape Character Area Assessment SPD (October 2006)**

This document provides detailed guidance on the Bradford Districts key landscape character areas and how development should be managed within them. It is advised for the Wilsden Landscape Character Area that any new development should ensure Wilsden's separation from nearby villages. It warns that suburban sprawl would impact the unique character of historic villages such as Wilsden by diluting the physical boundaries between itself and nearby settlements (Harden and Cullingworth). It is also suggested that any

new development is located where it can be hidden, so not to compromise the integrity of the Wilsden Character Area, which is already perceived as a busy and quite crowded landscape.

### **Householder SPD (April 2012)**

This document provides design principles on how householder developments (i.e. extensions) can be carried out in accordance with local planning policies. For example, residential extensions will be supported where they do not compromise privacy of neighbouring properties, overly obstruct/dominate the original building, and are made of materials that either match or complement the original building.

### **Homes and Neighbourhoods: A Guide to Designing in Bradford SPD (February 2020)**

The guide seeks to deliver a change in the quality of new housing developments in the Bradford District based on a vision for 'green, safe, inclusive and distinctive neighbourhoods that create healthy communities for all.' The document sets out eight priorities for homes and neighbourhoods, based off the key issues identified by numerous community stakeholders from around the Bradford District.

### **South Pennine Moors SPA / SAC Supplementary Planning Document (SPD)**

The SPD sets out the recommended developer contribution (tariff) payable in order to avoid or mitigate any adverse impacts on the internationally protected species and habitats, that arise from development that falls within these zones. The monies collected will be used to fund a series of measures as part of the strategic mitigation strategy for the management of the SPA/SAC.

### **Wilsden Conservation Area Appraisal (January 2007)**

This document outlines the defining features of Wilsden's Conservation Area. By identifying what constitutes Wilsden's local distinctiveness this document includes methods and strategies which can be implemented to manage any future development within the Parish.

Other relevant policy documents that form part of the statutory development plan for Bradford District include:

### **Waste Management DPD (October 2017)**

### **Bradford Replacement Unitary Development Plan (RUDP) (May 2005) – Saved Policies**



**Place Assessment**

**02**



## 2. Place Assessment

### 2.1 Historic Evolution & Heritage

Wilsden historically developed from a number of scattered farmsteads at Hewenden, Hallas Bridge, Mytholme, Wilsden Hill, Norr, Wilsden Lee and Ling Bob. From the 19th century the textile industry led to the rapid development of the village resulting in the densely built up village centre. In 1883, the railway crossing the Hewenden viaduct opened, with Wilsden Station opening for freight in 1884 and passengers in 1886. In 1955, the Station was closed to passengers and in 1963 was closed completely. From the mid-20th century to the present day, the village's growth has predominantly comprised residential housing estates at the edge of the main settlement. This modern form of development has resulted in reduced levels of permeability across the village with many cul-de-sac streets restricting pedestrian and cycle connectivity.

There are over 20 Listed buildings and one Scheduled Monument within the Parish. A number of these are presented on page 13 and 23. There are also 40 Non-Designated Heritage Assets and two areas identified as special character areas. These are Hallas Bridge and Birkshead. The historic centre of Wilsden is designated as a Conservation Area.



Historic mapping from 1852



Historic mapping from 1943 showing Hewenden Viaduct and Wilsden Station to the west of Harecroft



Historic mapping from 1942





Grade II Listed Hewenden Viaduct



Grade II Listed 71 - 77 Main Street



Grade II Listed Bents Mill, Hallas Bridge

AECOM

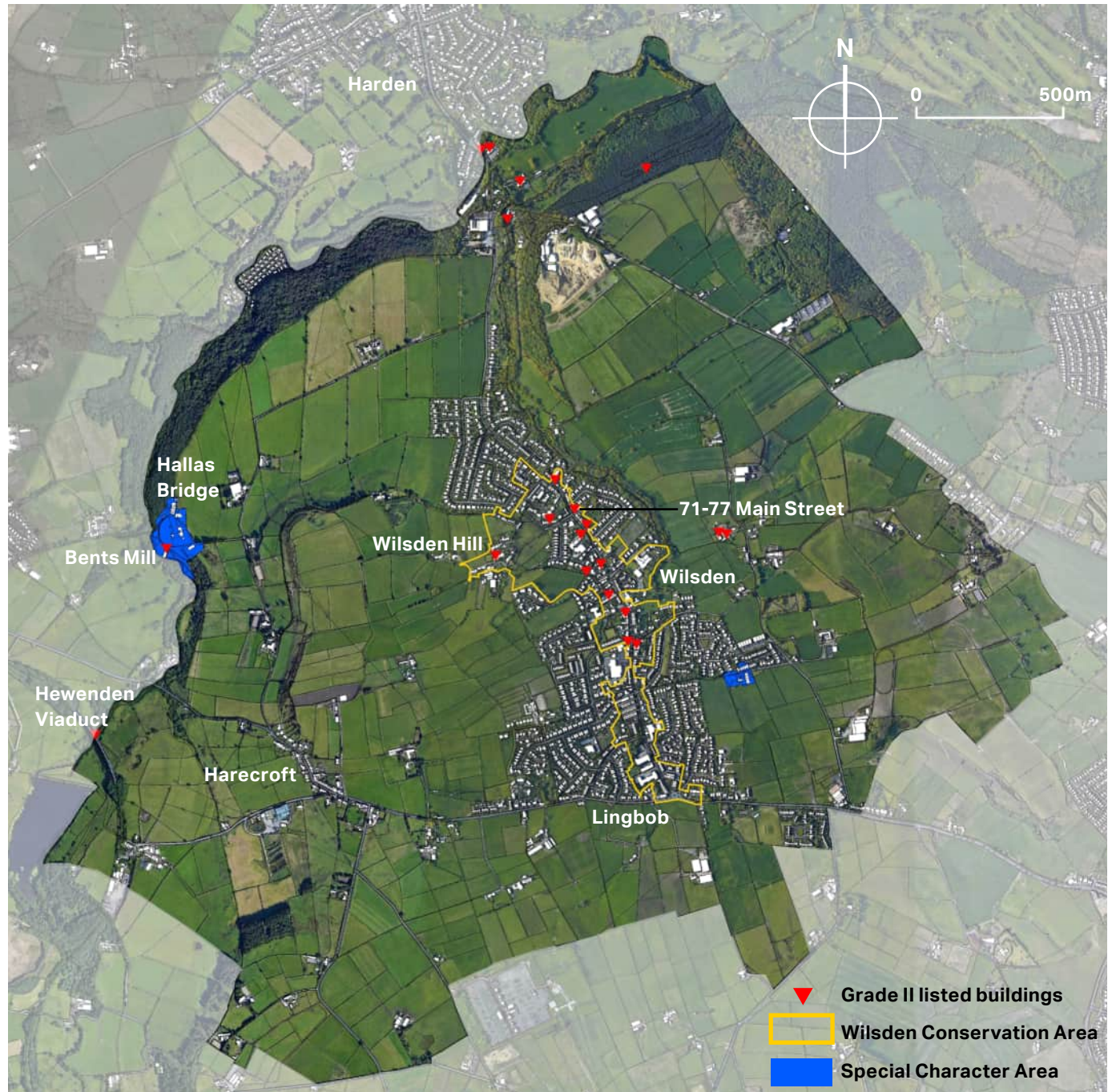

Map showing heritage assets, Conservation Area and special character areas



## 2.2 Landscape

The surrounding landscape is predominantly enclosed farmland with dry stone wall bound fields. There are a number of densely wooded areas within the parish boundary including Ruin Bank Wood, Crag Wood and Goitstock Wood. Wilsden is situated within a sloping landscape falling from Lingbob in the south, towards Harden Beck in the north. The level change from the southern edge of the neighbourhood area boundary to Harden Beck in the north is approximately 145m (See page 15).

Wilsden Parish sits within Natural England's National Character Area 37. Yorkshire Southern Pennine Fringe. The area is described as having close conjunction between rural landscapes and the rich industrial heritage of the urban areas. Urban development is described as constrained within valley floors and up side slopes, with location and layout strongly influenced by landform. There are many extensive and dramatic views from higher land out over lower-lying land and even from within urban

areas. Treeless hill tops with woodland on steeper valley sides give the impression of a well-wooded landscape.

At a local level, the neighbourhood area straddles two of the Landscape Character Areas (LCA) identified in the City of Bradford MDC Landscape Character SPD, 2008. These are Wilsden LCA and Thornton and Queensbury LCA.

Within the Wilsden LCA, key landscape elements include rolling, concave plateau landform, strong field pattern with stone wall boundaries and significant woodland cover.

Within the Thornton and Queensbury LCA, key landscape elements include pylons, scattered tree cover and pasture with gritstone walls.

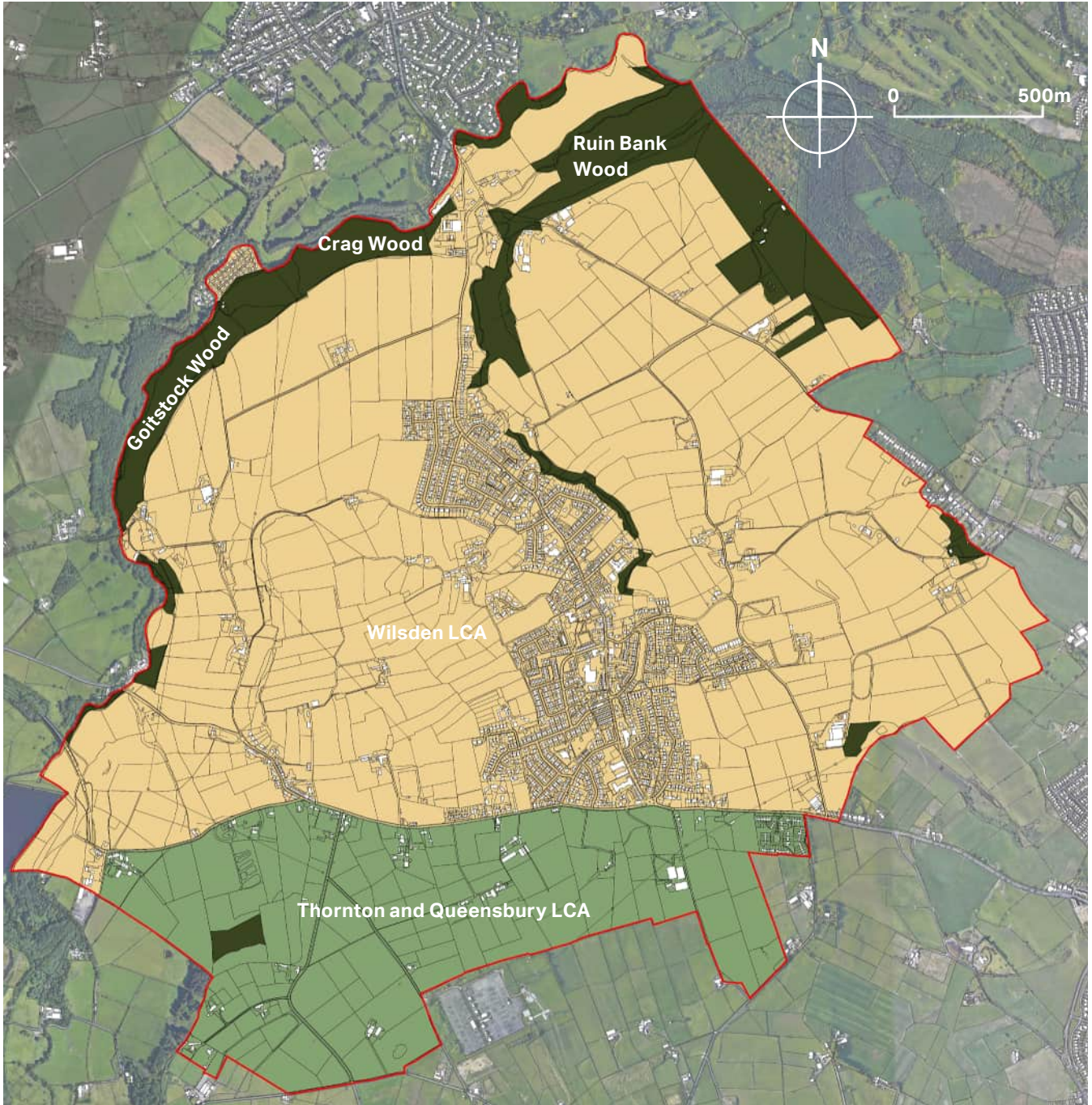

- Woodland
- Thornton and Queensbury LCA
- Wilsden NP Area
- Wilsden LCA

Landscape





Topographical cross section of Wilsden illustrating the level change across the village



## 2.3 Route Hierarchy

Wilsden is situated approximately 4 miles to the north west of Bradford. The streets in the parish comprise predominantly of cul-de-sac access streets and estates.

The primary route through the village is Main Street / Harden Lane which connects the B6144 to the south of the village with Harden to the north of the village.

Main Street is the historic linear route which runs through the centre of Wilsden providing access to Harden in the north. Lane Side also runs through the historic linear settlement of Harecroft providing links to Cullingworth and Haworth to the west.

There are bus services in Wilsden providing access to Bradford, Harden, Bingley, Eldwick, Keighley, Sandbeds, Cullingworth, and Harecroft.

The surrounding area is well connected with public right of way routes providing traffic free footpaths to explore the surrounding landscape. In addition, the Millenium Way footpath and Calder / Aire Link bridleway run through the parish.

A traffic free section of National Cycle Network Route 69, 'the Alpine Route', runs through the neighbourhood area along the disused railway line crossing the grade II listed Hewenden Viaduct. National Route 69 connects Morecambe with Grimsby, passing beautiful canals and stunning scenery.

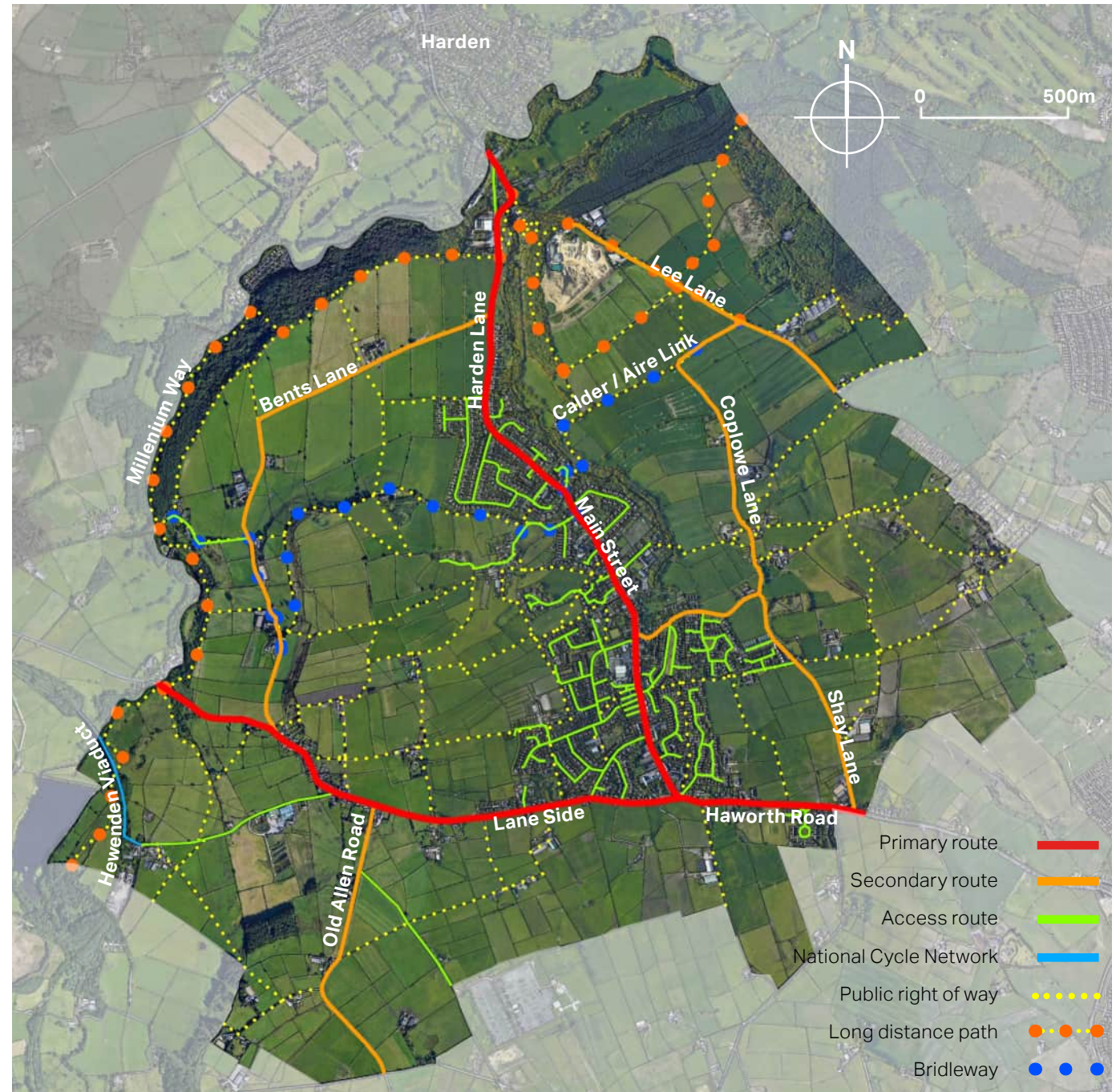

Route Hierarchy





Harecroft



Harden Lane



Old Allen Road



Main Street



Shay Lane



Bents Lane



## 2.4 Village & Open Space Structure

The parish is comprised the main settlement area of Wilsden, small linear settlement of Harecroft as well as scattered dwellings and farms within the surrounding landscape. The majority of the local amenities are found in Wilsden along or just off Main Street. There are two churches in the parish, outdoor sports and recreation space and an allotment. There are also five public houses in the parish, together with a primary school, pharmacy, doctors surgery and dental practice. There is also a community owned Post Office, Co-op convenience store and a butchers.



Trinity Church



The Villager Pub

AECOM

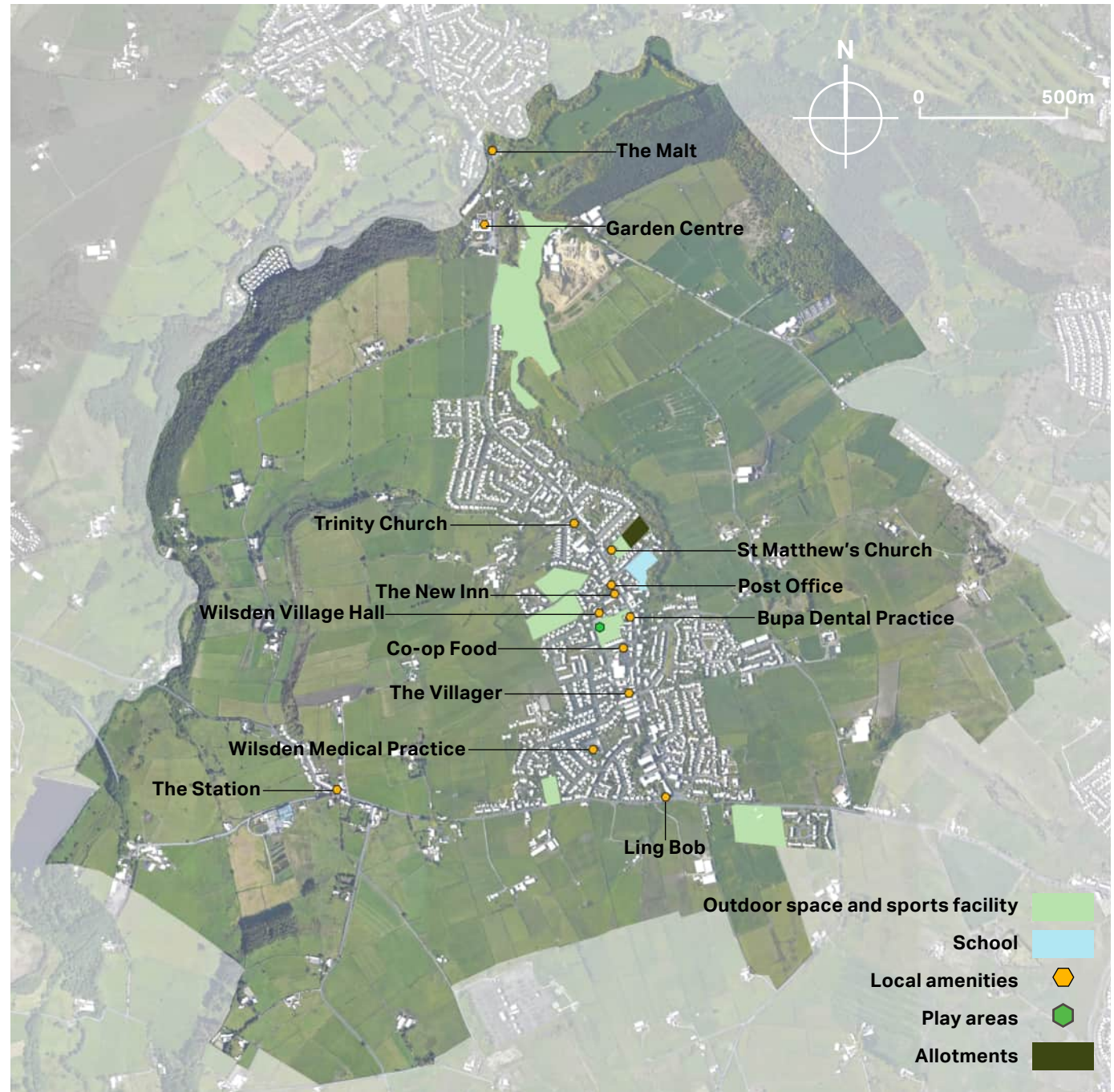

Village Structure and Open Space





Ling Bob Pub



The New Inn



1 hectare housing density samples

On the adjacent plans the following 1 hectare housing density samples have been tested to understand the density of existing development within the village, in order to inform future development.

1. Harecroft - 21 dwellings per hectare (dph)
2. Birchlands Avenue / Florence Avenue - 27dph
3. High Meadows - 10dph
4. Farndale Road - 28dph
5. Main Street / Peel Street / Wellington Street / Albert Street / Victoria Street / Queen Street - 35dph
6. Manor House Road - 25dph
7. Lingfield Road / Byland Court / Tempest Close - 19dph
8. Birkshead Drive / Birkshead Mews - 27dph

The historic phased growth of the main settlement area has resulted in some settlement edge areas of housing where densities have not been reduced to respond to the sensitive edge, at the interface between built and natural environments. This can result in a hard urban edge to the main settlement area and have an adverse impact on the surrounding landscape. The lowest density samples (3 & 7) are predominantly large housing. The Wilsden Neighbourhood Plan Housing Mix policy will limit future housing developments with 4 or more bedrooms.



## 2.5 Sense of Place & Wayfinding

The elevated position of Wilsden has resulted in many view points where the surrounding landscape can be appreciated (see views 2, 3, 6, 7, 10 and 12). The views shown are not exclusive. Further detail on views can be found within the Wilsden Neighbourhood Plan supporting evidence document on Important Views and Vistas.

Main Street, the central route through the village has a strong historic feel with most of the historic buildings in the area lining this route.

There are a number of historic listed buildings which contribute to the character of the parish. The Grade II listed Hewenden Viaduct is a prominent landmark which can be seen from Harecroft (see view 3). Prospect Mill on Main Street is a tall and prominent landmark building within the village centre. The Grade II listed Wilsden Wesleyan Sunday School is another village centre landmark building owing to its architectural detailing.

The influence of the surrounding landscape contributes to the rural character of the area. The woodland setting to the north of the village reinforces the rural character and provides a natural break between Wilsden neighbourhood area and the adjacent Harden area.

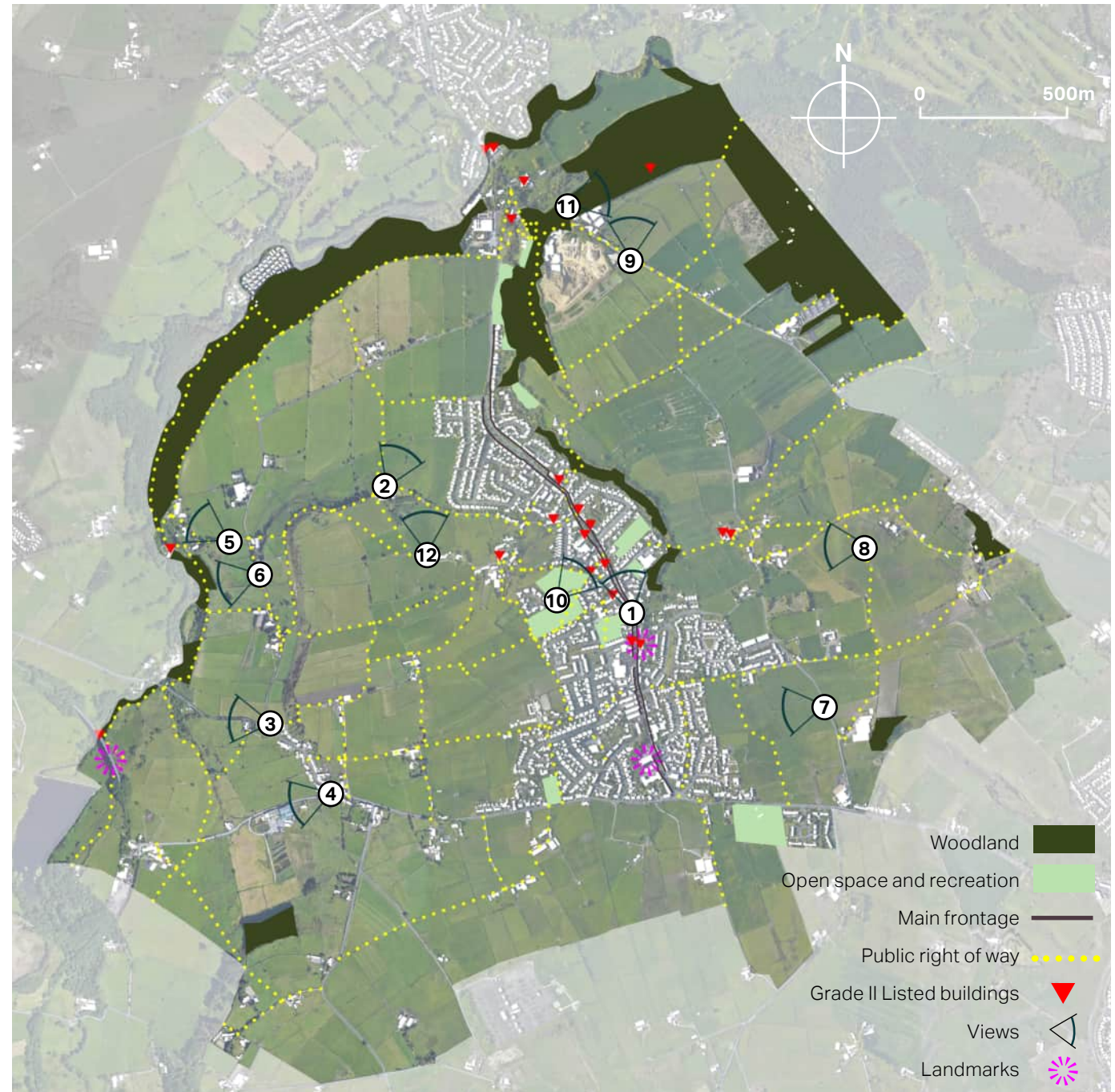

Sense of Place and Wayfinding





View 1 Looking north from Main Street



View 2 from Wilsden Hill



View 3 looking west from Bents Lane



View 4 looking west from Station Road



View 5 looking north-west from Hallas Bridge Lane  
AECOM for: Wilsden Neighbourhood Plan Steering Group



View 6 looking west from Bents Lane





View 7 looking west from Shay Lane



Tall building / landmark - Prospect Mill, Main Street



View 8 looking west from Norr Hill



View 9 looking north from Lee Lane



View 10 looking north-east from High Meadows  
AECOM

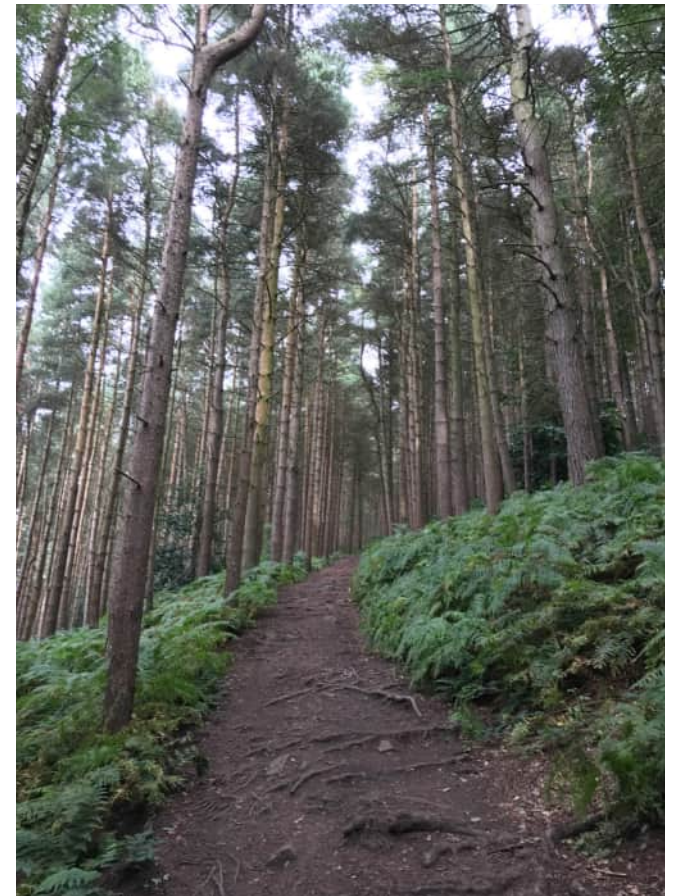

View 11 looking east within Ruin Bank Wood





*View 12 looking north from Dye House Lane*



*Grade II Listed Mechanics Institute*



*Grade II Listed Wilsden Wesleyan Sunday School*



*Grade II Listed 4-20 Club Row*



*Grade II Listed 134-136, Main Street*



*Grade II Listed Malt Inn*



*Grade II Listed Woodlands Farmhouse*



*Grade II Listed Harden Grange Folly / St David's Ruin*





Local Character

03



# 3. Local Character

## 3.1 Photographic Analysis and Observations

A site walkover of the villages was undertaken by AECOM on the 12th August 2021 to understand the topography, form and character of the Neighbourhood area.

Following the visit, a photographic analysis has been prepared to identify and illustrate key design features which help underpin Wilsden's intrinsic character. This understanding was used to inform and shape the proposed design codes.

The images which have been chosen for the purpose of this analysis represent a sample from across the Neighbourhood Plan area as illustrated in the adjacent key plan. Each of the images portrays key characteristics / spatial responses which help to shape the sense of place. Some details are also highlighted that do not contribute to local character.

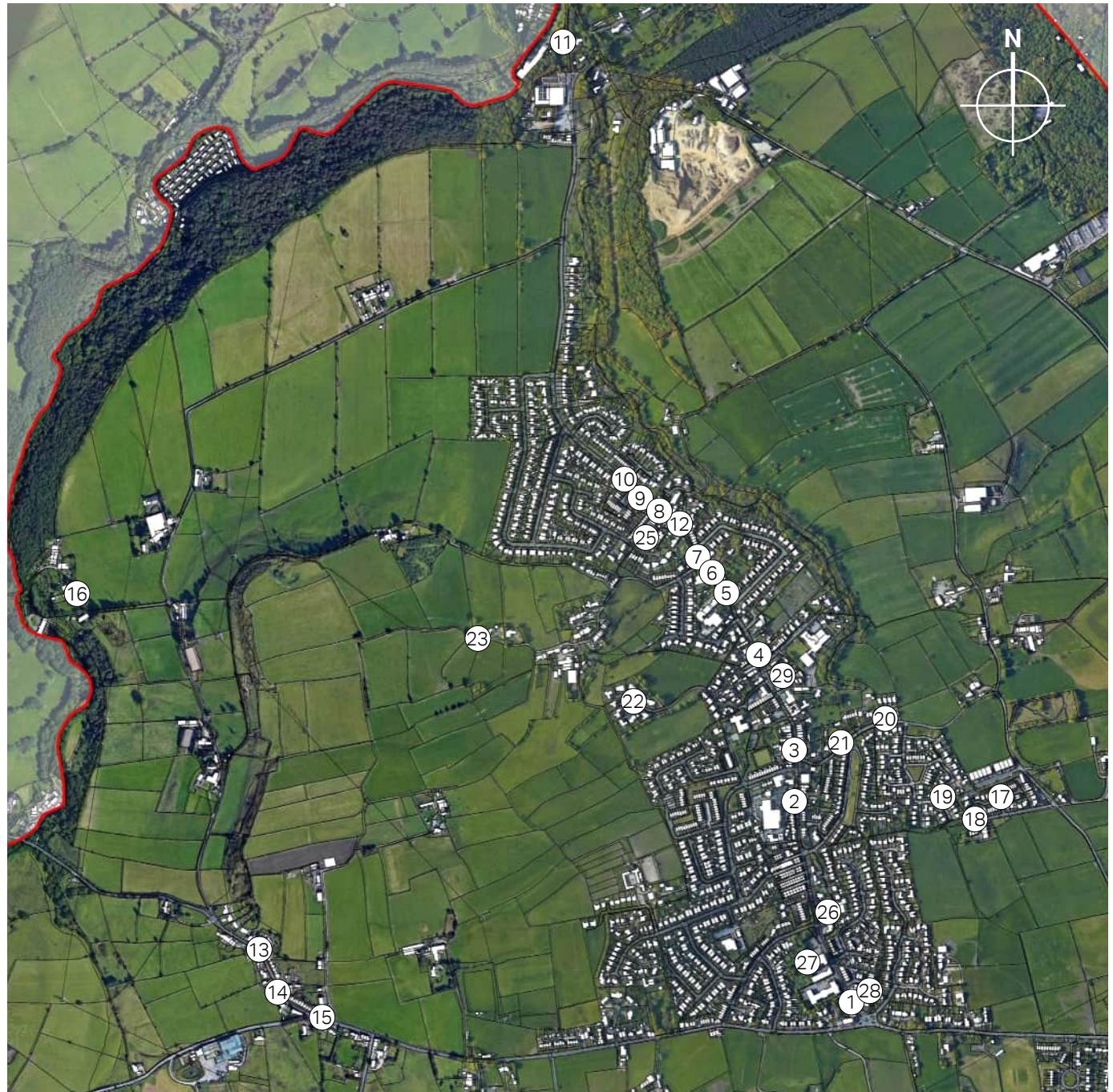

Wilsden Photo Analysis Key Plan





**Photograph 1: Main St at Lingbob**

1. Two storey terraces directly fronting the street
2. Diminishing course Yorkshire stone façade
3. Stone window detailing including mullions, headers and sills
4. Stone door surrounds
5. Loft space utilised with skylight windows
6. Large stone quoins blend with the building's façade
7. Original windows and doors replaced with white UPVC alternatives
8. Gable slate roof with stone corbels
9. On-street parking



**Photograph 2: Main St**

1. Row of two storey terraces
2. Properties setback with front gardens bounded by medium-rise stone walls
3. Yorkshire stone façade
4. Simple window headers and sills made from local stone
5. Traditional windows replaced with white UPVC alternatives
6. Front doors set back within a stone surround with a protruding header
7. Gable slate roof



**Photograph 3: Cragg House, Main St**

1. Two storey semi-detached dwellings
2. Set back with front gardens bounded by low-rise stone boundary walls, hedging and gate post/gated access
3. Yorkshire stone façade
4. Ground floor canted bay window with decorative mullions
5. Simple stone window lintels and sills
6. Dentil masonry adorning roofline
7. Gable slate roof with stone coping





**Photograph 4: Wilsden Mechanics Institute, Main St**

1. Conversion of Grade II Listed building into several two storey mews dwellings
2. Slight setback with iron railing boundary
3. Yorkshire stone façade
4. Stained wood windows and doors
5. Simple stone window headers and sills
6. Ornate door header protruding from façade



**Photograph 5: Grade II listed former weavers' cottages, Main St**

1. Three storey townhouse conversion of Grade II Listed former weavers' cottages
2. Masonry arch
3. Stone band course running along the second storey windows
4. Stone window detailing including mullions, headers and windowsills
5. Timber sash windows painted in varied colours (black, white, brown)
6. On-street parking



**Photograph 6: Main St**

1. Dwelling boundaries flush with back edge of pavement
2. Variety in the streetscape's building heights, architectural detailing, gable end orientation and façade treatment.
3. Predominantly stone facades bar one with a white/cream render
4. Stone detailing including band courses, window headers and sills, and door surrounds.
5. Both front-gabled and side-gabled slate roofs
6. On-street parking





**Photograph 10: Bartle Court**

1. More recent development two to four storey terraces/ townhouses
2. Conservation Area development with less appropriate scale and materials
3. Terraces setback with grassed front gardens bounded by low-rise iron fencing. A relatively weak boundary compared to previous examples (e.g. stone walls).
4. Townhouses setback with tarmac driveways. The lack of any physical/visible separation between dwellings creates sense of boundary ambiguity.
5. Stepped gable roof
6. Stone detailing includes band course, door surrounds, mullions, and window headers and sills.



**Photograph 11: Mill Hill Top**

1. Row of two storey traditional cottages
2. Front garden setbacks separated from street by medium-rise stone boundary wall. Painted timber gates at access points
3. Local stone façade almost completely covered by planting
4. Gable slate roof
5. Top hung four pane PVC windows
6. Contextually responsive garage extension protruding from original structure
7. On plot parking provided within an integrated stone garage



**Photograph 12: Main Street**

1. Row of two storey terraces with strong vertical alignment
2. Continuous roofline between dwellings despite gradient of street
3. Setback from street behind front garden bounded by low-rise stone wall with gatepost and gate access.
4. White UPVC windows replacing original windows
5. Local stone façade and window and door surrounds
6. Off road parking to rear





**Photograph 13: Harecroft**

1. Two storey semi detached dwellings with variety in height
2. Driveway and front garden setback with a low-rise boundary stone wall
3. Contextually responsive two storey side extension
4. Timber sash windows
5. Fine grain local stone façade
6. Dentil masonry adorning roofline
7. Stone covered gable roof with stone coping



**Photograph 14: Harecroft**

1. Recent development of three storey semi-detached and detached dwellings. Third storey provided within the roof space.
2. Boundary lines between the properties are obscured due to a lack of a physical/visible separations
3. Dormer clad with UPVC
4. Set back from street with tarmacked driveway and omission of any planting.
5. Façade and window detailing (headers, mullions and sills) made from local stone
6. Both side-gable and front-gable orientation covered with an artificial slate material



**Photograph 15: Harecroft**

1. Row of two storey terraces stepped in response to the street's topography
2. Setback with front gardens bounded by medium-rise stone walls with gatepost/gate access
3. Band course running along first storey windowsills
4. Local stone façade and window headers, sills and door surrounds
5. Predominantly white UPVC windows
6. Gable slate and stone covered roofs
7. Regular chimneys along the terrace, provide a distinctive roofline





**Photograph 16: Hallas Bridge**

1. Two storey semi detached dwellings
2. Deep setback with long concrete driveway and front garden bounded by stone walling
3. Coarse grain stone façade
4. Large sash window with narrow stone headers and sills
5. Gable slate roof with stone coping
6. View of dwellings obscured by mature trees
7. Flat roof garage extension
8. Projecting front gable porch



**Photograph 17: Birkshead Mews**

1. Recent development of two storey semi-detached dwellings and three storey townhouses
2. Set back from street with driveways and front gardens with no boundary treatments.
3. Parking provided on tarmacked driveways
4. Side-gables with projecting front-gable roofs
5. Coarse grain local stone façades
6. Both high-rise stone walls with timber fence detailing bounding townhouse gardens
7. Development is on the site of the former Birkshead Mill.



**Photograph 18: Birkshead Drive (part of the former agricultural hamlet of Birkshead which pre-dates the Industrial Revolution)**

1. Streetscape characterised by mix of old and new development with varying heights
2. Setbacks are of same/similar size and house either front gardens or tarmacked/gravelled driveways
3. Coherent and continuous streetscape due to dwelling frontages aligning
4. Parking provided on driveways beside dwellings
5. On-street parking
6. Local stone facades
7. Stone wall boundaries to the front garden, which also separate properties





**Photograph 19: New Holland Drive**

1. Recent development of two and three storey detached dwellings
2. Dwelling boundaries particularly weak compared to previous examples. Lack of both walling/gating and planting in creating physical separations between public and private land.
3. Parking provided on brick driveways
4. Side-gables with projecting front-gable roofs
5. Coarse grain local stone façades
6. Artificial slate roofing
7. Particularly illegible streetscape due to repeated building typologies and irregular and twisting streets that lack any distinguishable features in aiding wayfinding
8. Ground floor bay and box windows
9. Stone sills and lintels



**Photograph 20: Broomfield, Crack Lane**

1. Recent development of two and three storey detached dwellings. Third storey provided within the roof space.
2. Local stone facades characterised by a greyer tone than previous examples
3. Stone window headers, windowsills and mullions
4. Side-gable with projecting front-gable roof
5. Stone roof ridges
6. Dwelling boundaries are stronger than previous newer development examples due to appropriate use of boundary walls and planting



**Photograph 21: Crack Lane**

1. Two storey detached dwelling
2. Setback bounded by dry stone wall with wooden gate access
3. Contextually responsive two storey side extension that has emulated façade and stone detailing of original structure
4. Dentil masonry adorning roofline
5. Centrally aligned doorway with ornate stone header
6. White UPVC windows replacing original windows with stone headers and sills
7. Slate roof with stone ridge and coping





**Photograph 22: High Meadows**

1. Recent development of two storey detached dwellings
2. Contextually responsive local stone facades with appropriate window headers, windowsills, and dentil masonry detailing
3. Slate roofs with stone corbels and coping
4. Significant setbacks with large brick driveways bounded by dry stone walling and ample planting
5. Gable slate roof
6. Cream UPVC imitation sash windows
7. Stone chimney breast with clay chimney pot
8. Roof mounted solar panels



**Photograph 23: Dye House Lane**

1. Two storey semi-detached cottages
2. Setback with front gardens bounded by a low-rise wall with decorative iron railings
3. Dwelling accessed via decorative stone gateposts and iron gate
4. Lead roof flashing detail
5. Diminishing course fine grain local stone façade
6. Cream sash windows
7. Side-gable roof with projecting front-gable porch
8. Traditional stone roof with stone ridge and corbels
9. Large stone quoining blending with façade



**Photograph 24: Spring Farm Mews**

1. Three storey detached building
2. Local stone boundary wall
3. Gable roof form
4. Stone window sills and lintels



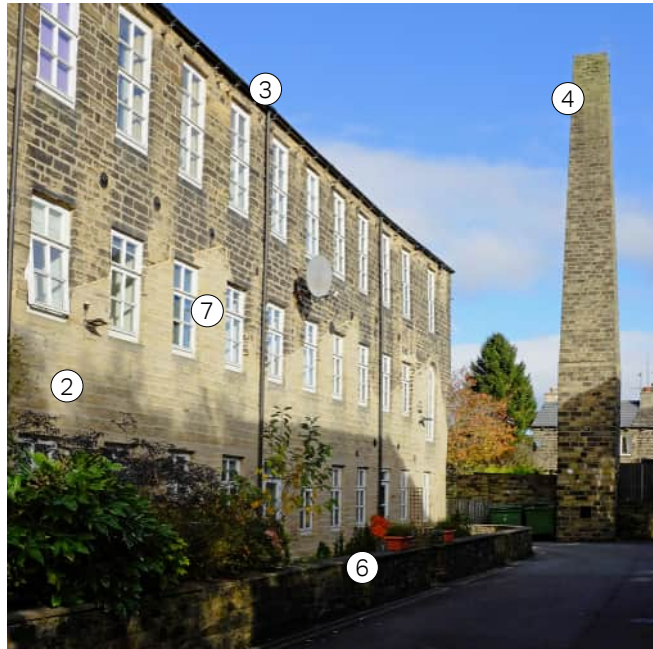

**Photograph 25: Providence Mill**

1. Mill buildings converted into residential use.
2. Local stone building materials.
3. Stone slate and slate roof tiles.
4. Former mill chimney retained.
5. Gable roof forms.
6. Low stone wall boundaries.
7. Stone sills and lintels.
8. Small skylights creating habitable roof space.



**Photograph 26: Well House Mill**

1. Two storey mill building currently under commercial use.
2. Gable roof form with stone slate roof tiles.
3. Arched central window.
4. Building set back from the street with stone front boundary wall.
5. Stone sills, lintels and mullions.



**Photograph 27: Prospect Mill**

1. Tall three storey mill building with an additional storey in the roof space.
2. Dentil stone detailing along eaves.
3. Gable roof form.
4. Local stone building elevations.
5. Stone sill string detailing.
6. Building sits at the back edge of the pavement.
7. Corbels where the corner of the roof meets the elevations.





**Photograph 28: Lingbob Mill**

1. The site of Lingbob mill has undergone conversion to residential use with the former mill building also providing a number of dwellings.
2. Chimney retained on former mill.
3. Skylight windows on roof.
4. Material palette of local stone elevations and slate roof tiles.
5. Low stone boundary wall



**Photograph 29: Main Street**

1. Land of former Albion Mill is now occupied by a small residential development of two storey dwellings.
2. Low stone wall front boundary with metal railing.
3. Local stone elevations.
4. Concrete roof tiles.
5. Development set back behind a grass verge.



## 3.2 Key Findings and Opportunities

- Settlement edge development should sensitively respond to the surrounding landscape with lower densities and larger plot sizes and gardens. Lower densities and a dominance of soft landscaping will support a soft transition from the settlement to the surrounding landscape. The density of development will need to be compliance with Core Strategy Policy HO5 (and any successor policy in the Local Plan, when adopted)
- Pathways providing onward connectivity at the settlement edge provide accessibility to the surrounding landscape.
- Typical building heights across the parish are 2 to 3 storeys which should be responded to in future development. It is appropriate to create additional storeys within the roof space of a dwelling.
- Parking should be provided on plot and preferably out of sight to avoid cluttering the street scene.
- Views of the unspoilt woodland and surrounding landscape have a positive influence on local character and should be protected.
- A material palette of Yorkshire stone elevations and slate and stone roofing is most appropriate for development in the parish. The historic parts of Wilsden are most sensitive to deviation from this palette.
- Well integrated and designed renewable energy sources should be encouraged within future developments and building orientation and spacing.
- Former mill buildings can be sensitively converted into residential use by preserving the building's industrial character.
- Low stone boundary treatments fronting small front gardens are a strong characteristic of the village.



A photograph of a rural landscape featuring traditional stone buildings with slate roofs. In the foreground, there is a gravel path, a stone wall, and a hedge. A large green circle is overlaid on the center of the image, containing white text. The background shows rolling hills under a cloudy sky.

**Character Areas and  
Design Codes**

**04**



# 4. Character Areas and Design Codes

## 4.1 The Codes

Based on the understanding gained in the previous sections, this section will identify design codes for future developments to adhere to. The following design codes have been created to apply to some or all of the areas defined for coding:

Code 1 - Sustainability and Climate Change

Code 2 - Landscape, Views and the Settlement Edge

Code 3 - Building Design

Code 4 - Parking, Gardens and Boundary Treatments

Code 5 - Privacy, Space and Natural Surveillance

## 4.2 When to Use the Codes

The table below identifies when each of the codes should be used. A prefix has been created for each code to allow simple application of the design codes to the coding/character areas on the following page.

Code	Prefix	When to use the code
Sustainability and Climate Change	1A	Code to be applied to all future housing developments in Wilsden Neighbourhood Plan area to reduce water wastage and flood risk and tackle climate change.
Landscape, Views and the Settlement Edge	2A	Code to be applied when a housing development is proposed within the green gaps which separates the villages from their neighbouring settlements.
	2B	Code to be applied when a housing development is proposed within the land / garden of an existing dwelling.
	2C	Code to be applied where a housing development could impact upon views to the surrounding landscape.
	2D	Code to be applied where a housing development could impact upon views towards the villages from the surrounding landscape.
	2E	Code to be applied when the arrangement of a housing development's layout could restrict views to the surrounding landscape.
	2F	Code to be applied when a proposed housing development has the potential to restrict views to local landmarks.
	2G	Code to be applied when a proposed housing development has the potential to impact on the transition space between the developed settlement area and the surrounding landscape.
Building Design	3A	Code to be applied when determining the height and scale of future housing developments.
	3B	Code to be applied when historic buildings are proposed for conversion into residential use.
	3C	Code to be applied when determining the material and detailing palette to be used in a housing development.
Parking, Gardens and Boundary Treatments	4A	Code to be applied when designing how parking will be provided within future housing developments.
	4B	
	4C	
	4D	
	4E	Code to be applied when selecting the boundary treatments to be used within future housing developments.
	4F	Code to be applied when designing the back gardens of future housing developments.
Privacy, Space and Natural Surveillance	5A	Code to be applied when designing the space between dwellings in future housing developments.
	5B	Code to be applied when designing the orientation of buildings and plots to ensure appropriate levels of security and surveillance are met.

Table 1: When to use the codes



## 4.3 Defining Areas for Coding

For the purpose of Design Coding the Neighbourhood Plan area has been divided into the following 4 areas:

### 4.3.1. Historic Character Area

### 4.3.2. Harecroft Character Area

### 4.3.3. Post-war/Modern Character Areas

### Rural Surrounding Landscape

This character area comprises 3 areas surrounding Wilsden's main settlement area. These are:

### 4.3.4 Harden Beck Valley;

### 4.3.5 Wilsden Hill & Harrop; and

### 4.3.6 Norr & Birkshead

On the following pages a description of each character area is provided and the design codes that apply to each area are identified.

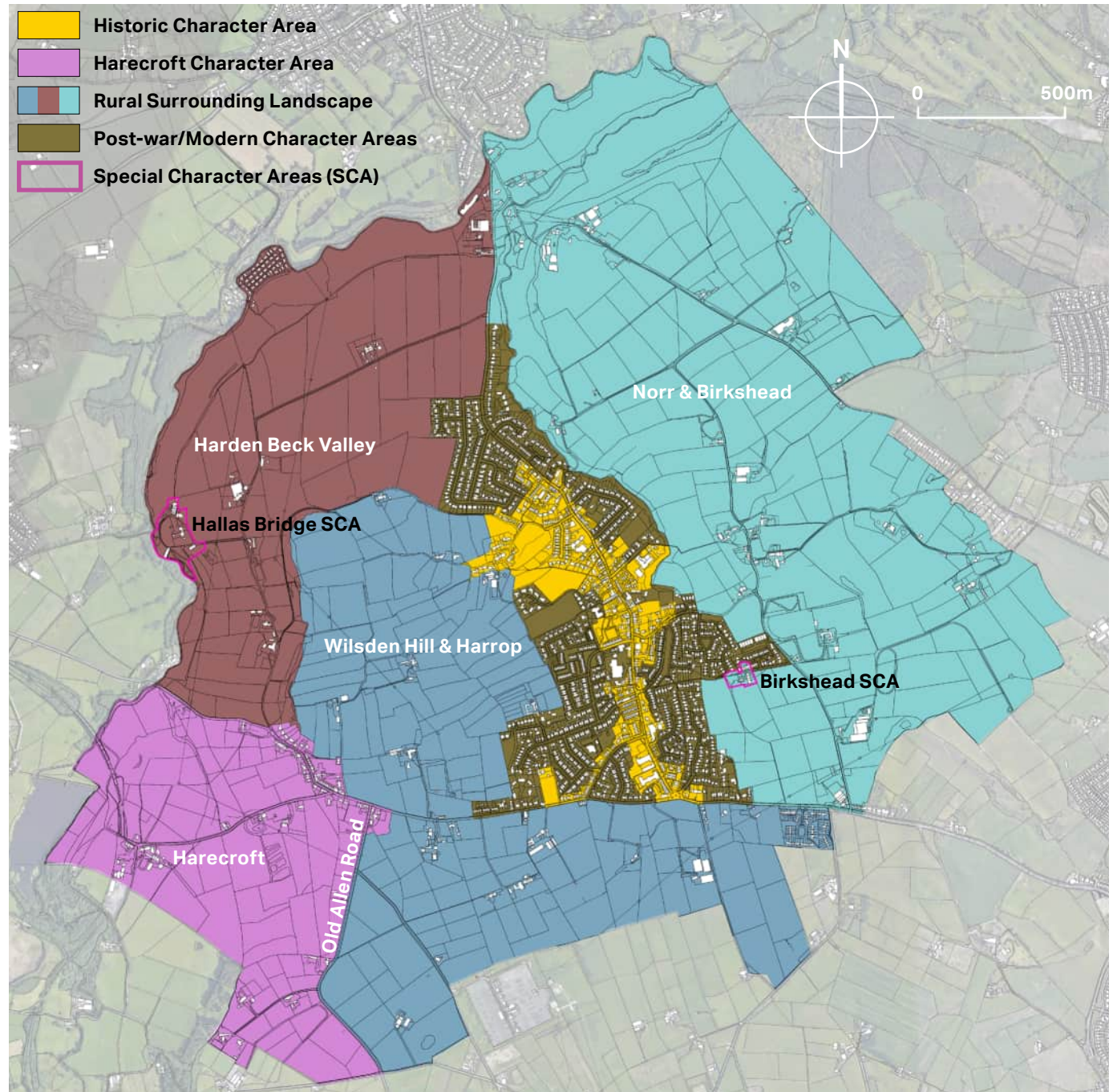

Where to apply the design codes



### 4.3.1 Historic Character Area

This area comprises the Wilsden Conservation Area plus some additional areas of historic character. The historic character in this area strengthens the village's sense of place. Development in this area is sensitive to change and the degradation of the historic character should be avoided.

This area is where most of the terraced dwellings within the parish are located as well as the majority of the historic mill buildings. There is a uniformity to the material palette in this area which most buildings adhere to with local stone elevations and stone slate or slate roof tiles. Building heights are more varied within this character area with numerous three storey buildings as well as the taller mill buildings and chimneys. The streets in this area are generally direct routes providing onward connectivity. There are some cul-de-sacs but these tend to be short streets which do not degrade the legibility of the villages movement network.

A possible development site at Crooke Lane partially sits within this character area. Proposals on this site should strive to respond to the historic character of this area.

Design Codes that apply to this Character Area

1A, 2B, 2C, 2E, 2F, 3A, 3B, 3C, 4A, 4B, 4C, 4D, 4E, 4F, 5A, 5B





### 4.3.2 Harecroft Character Area

This area comprises the historic village of Harecroft and the landscape to the south up to Old Allen Road. The area includes assets from Wilsden's railway heritage including the Hewenden Viaduct.

Harecroft is classified as a settlement that is washed over by the Green Belt under saved Replacement Unitary Development Plan (2005) - Policy GB3.

Harecroft has historically developed in a linear settlement pattern along Lane Side. Later additions to the village have comprised infill developments and have also adhered to the existing linear village pattern. The building material palette of local stone elevations and slate or stone slate roof tiles has generally been adhered to across most of the built form. Views can be seen through breaks in the building line across the sloping landscape which falls towards the south-west, towards the Hewenden Reservoir and Viaduct. The landscape comprises rolling dry-stone wall bound fields and a few small clusters of woodland.

Design Codes that apply to this Character Area

1A, 2B, 2C, 2D, 2E, 2F, 3A, 3B, 3C, 4A, 4B, 4C, 4D, 4E, 4F, 5A, 5B



View from Hewenden Viaduct to Harecroft



### 4.3.3 Post-war / Modern Character Area

These areas comprise of the later additions to the Wilsden settlement area. These areas largely comprise of cul-de-sac and estate-like development patterns. Any future redevelopment opportunities in this character area should look to reinstate connectivity from the historic core through to the surrounding countryside.

A possible development site at Crooke Lane partially sits within this character area. Proposals on this site should strive to respond to the historic character of the Historic Character Area.

Any future changes to the Settlement Boundary will abut this character area. Proposals should respond to their Green Belt setting and the character of the landscape character areas they sit within.

Design Codes that apply to this Character Area

1A, 2B, 2C, 2D, 2E, 2G, 3A, 3C, 4A, 4B, 4C, 4D, 4E, 4F, 5A, 5B

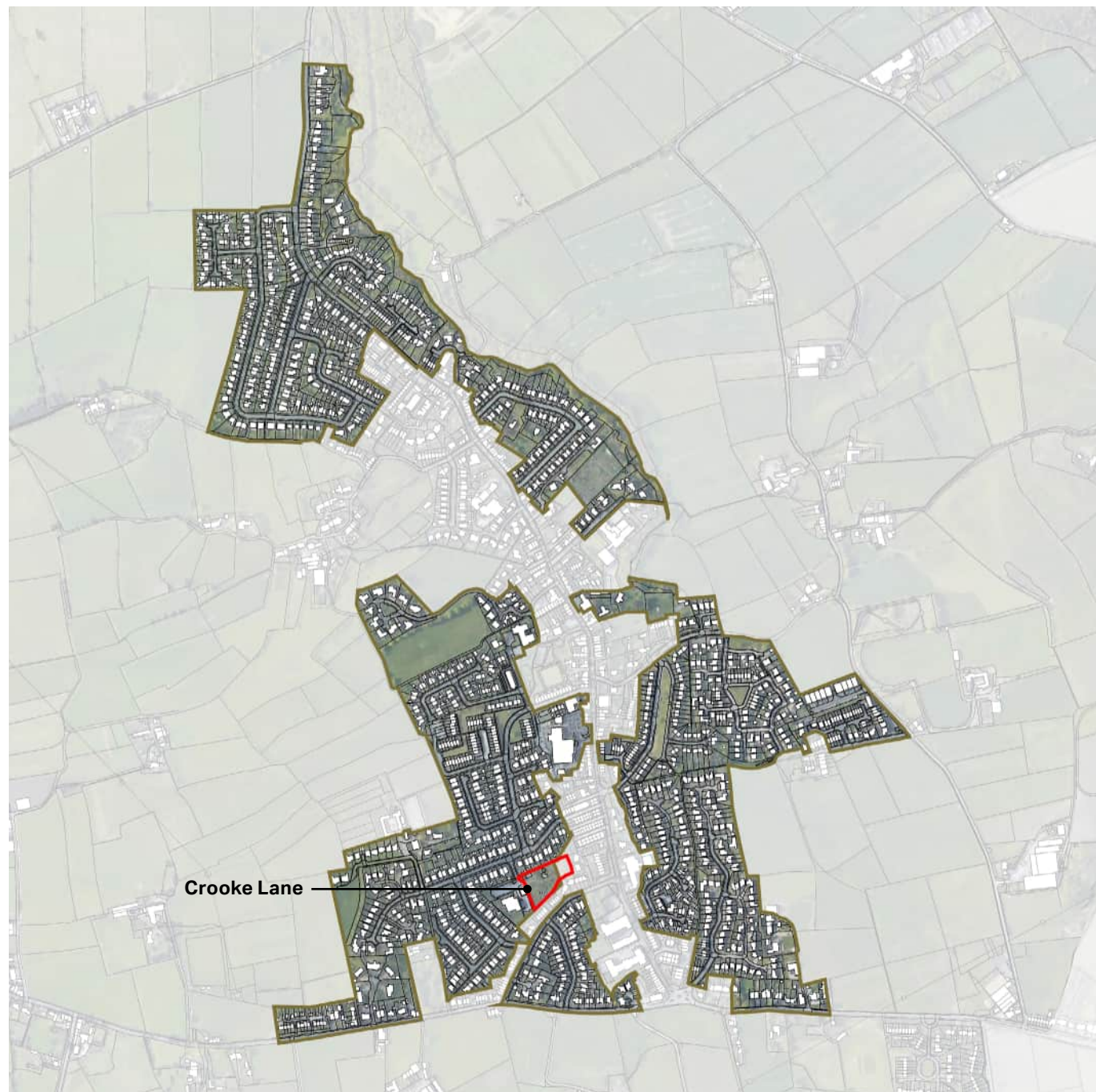



### 4.3.4 Rural Character Area: Harden Beck Valley

The Harden Beck Valley character area has a sense of separation from the main settlement area due to the sloping nature of the landscape falling away from the village towards Harden Beck. The scattered farms and small clusters of housing along Bents Lane are broken up by large gaps where no development occurs. The irregular placing of buildings along this route give this area an organic and rural character. Also within this character area is the Hallas Bridge Special Character Area which has a distinct historic character with dwellings and the former industrial Bents Mill nestled in the woodland setting.

Design Codes that apply to this Character Area

1A, 2A, 2B, 2C, 2D, 2E, 2F, 2G, 3A, 3B, 3C, 4A, 4B, 4C, 4D, 4E, 4F, 5A, 5B.



View from Hewenden Viaduct of Harden Back Valley



### 4.3.5 Rural Character Area: Wilsden Hill & Harrop

This area comprises the landscape between Harecroft and Wilsden as well as the landscape to the south of the village. The area sits entirely within the Green Belt. Farms and dwellings are scattered across the landscape with very few examples of large groupings of buildings (Windy Grove is the only exception to this). The landscape comprises predominantly of agricultural fields with dry-stone wall boundaries.

Design Codes that apply to this Character Area

1A, 2A, 2B, 2C, 2D, 2E, 2F, 2G, 3A, 3B, 3C, 4A, 4B, 4C, 4D, 4E, 4F, 5A, 5B





### 4.3.6 Rural Character Area: Norr & Birkshead

This area comprises the landscape to the east of Wilsden. The landscape is a mix of agricultural fields with dry-stone wall boundaries and densely wooded areas. The area sits entirely within the Green Belt. Farms and dwellings are scattered along Shay Lane Coplowe Lane and Lee Lane with large gaps between and very few examples of large groupings of buildings. Bank Top Quarry is also located to the north of this area.

Also within this character area is the Birkshead Special Character Area (SCA), which has a distinct historic character with three small clusters of terraced former agricultural workers cottages which are densely laid out. A significant number of these dwellings have retained their traditional features and details.

#### Design Codes

1A, 2A, 2B, 2C, 2D, 2E, 2F, 2G, 3A, 3B, 3C, 4A, 4B, 4C, 4D, 4E, 4F, 5A, 5B





## 4.4 Code 1 - Sustainability and Climate Change

### 1A - Sustainability & Energy

There are aspects of sustainable building design that go beyond the scope of Neighbourhood Plan policy. However, it is recommended that any new housing in the Wilsden Neighbourhood Area should mitigate its impact from the loss of countryside, wildlife and the natural environment and demonstrate that it is responding to climate change with the highest standards of insulation and energy conservation.

- Cavity wall and under floor insulation should avoid where possible heat loss through thermal bridging. Double or triple glazing, window and door draft sealing should reach Passivhaus standards wherever possible.
- All proposals must demonstrate sustainable surface drainage systems that will not unduly increase pressure on existing wastewater and natural drainage systems.



Precedent image - illustrating integration of sustainable urban drainage solutions



Precedent image - Optimising permeability in front gardens

- Gardens and parking areas should have the majority of their area landscaped, with permeable surfacing used on hard landscaped areas to enable rainwater absorption and reduce the rate of run off caused by development.
- New development should provide suitable and safe storage for bicycles of sufficient size. At least one secure space should be provided per dwelling in a garage of a suitable size or separate covered area within plot. Covered and secure cycle storage units are preferred but where enclosures are open suitable racks or hoops should be provided. Standards for cycling parking/storage provision are set out via Core Strategy Policy TR2 & Appendix 4.



Precedent image - safe, convenient and covered home cycle storage

- Solar, heat recovery, air source and ground source energy is encouraged in new development and should be designed to have a minimal visual impact on a development. Where technologies have a visual impact on sensitive areas (such as solar shingles and photovoltaic slates within or close to the setting of a heritage asset) they should be designed in from the start of the scheme. Designs should aim to conceal wiring and infrastructure and use carefully chosen slates or tiles on roofs to complement the solar panel materials. Where groups of housing are proposed they should demonstrate energy efficient heating through a combined heat and power system.



Precedent image - Solar tiles used to minimise visual impact

- Where appropriate, the orientation of buildings and roof pitches should incorporate passive solar design principles and allow for efficient solar energy collection. One of the main glazed elevations of future dwellings should therefore keep within 30° of south, when in keeping with the topography and clustering of existing buildings. Where it would be inappropriate for the main glazed elevation to be facing south or within



30 degrees of the this for the reason outlined above, every attempt should be made to design the roof so that it is of this alignment to allow for the fitting of solar panels This applies to all future dwellings whether solar panels are proposed or not to allow for retrospective implementation.

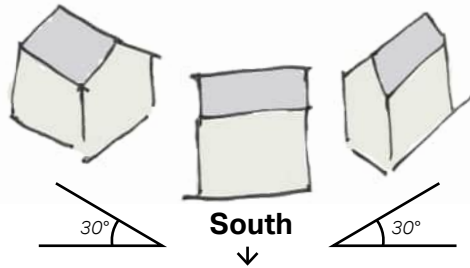

*Building/roof orientation for solar gain*

- New housing should demonstrate how rainwater and greywater will be stored and reused to reduce demand on mains supplies.

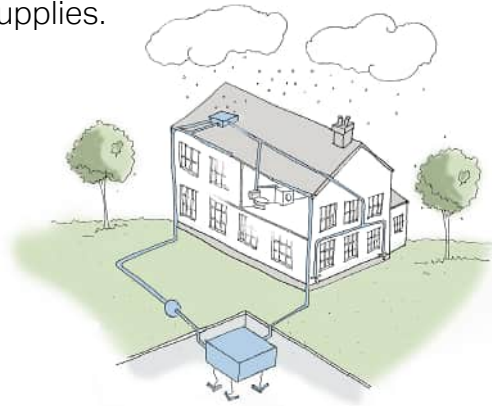

*Rainwater harvesting - collection and re-use*

- The installation of water butts within new residential developments is encouraged to collect rainwater from roofs and reduce the overall rainwater run off impact of any development.

- Where existing buildings are being converted or extended every effort should be made to introduce energy saving measures and new technologies to make the building more efficient and sustainable.
  - Whenever possible, developments should aim to re-use existing buildings and/or materials or procure reclaimed and recycled materials from local suppliers. Building materials made from construction and demolition waste are preferred to primary aggregates. Many types of construction waste can be used for these purposes including soil, asphalt, concrete, bricks and tiles. In conversion schemes roof tiles and slates should be carefully stored and re-used. In addition, priority should be given to materials that can be deconstructed and re-used at the end of the building's usable life.
  - Existing trees should be retained where possible. All proposed planting should be native species in order to promote and increase local biodiversity.
  - Residential developments should make space for wildlife and incorporate natural habitats into communal areas wherever possible. This will facilitate the delivery of Biodiversity Net Gain and reduce impacts on wildlife. Where natural green space is incorporated into development, designs should offer habitat connections to allow the movement of species through the development and avoid fragmentation of habitats.
  - Gardens and boundary treatments should be designed to allow the movement of wildlife and provide habitat for local species.
  - Swift bricks and bat boxes should be incorporated into every new residential development to help provide nesting and roosting spaces for bats and birds.
  - The use of green roofs and/or living walls is encouraged. These can assist with insulation and summer cooling requirements. They can also be readily integrated with solar systems and have even been shown to increase the efficiency of PV cells on hot summer days.
  - Open spaces should be located within walking distance of residential areas and linked through a series of green networks or corridors. Such linkages support a Green Infrastructure approach to development, allowing wildlife to move along corridors to access foraging opportunities and habitats and people to access a range of different recreational facilities.
  - New developments should provide Electric Vehicle (EV) charging points where practical. As a minimum, the installation of ducting or cable routes should be provided to allow for the installation of EV charging points in the future.
- Where a proposal falls short of these sustainable measures it must be explained why and what compensatory measures are being offered.



## 4.5 Code 2 - Landscape, Views and the Settlement Edge

### 2A - Village Separation

Within the Neighbourhood Area there are green gaps which currently provide a natural buffer and separate the villages of Harecroft and Wilsden from their neighbouring settlements. This degree of separation is something that the NPSG and wider community would like to retain in order to preserve the villages' structure and prevent sprawl.

Should a site come forward for development within or adjacent to this area, it will be necessary to respond sensitively and positively to the green gaps. It is therefore important that any future development in this area provides tree planting to screen the visual impact of development on the wider landscape.

Green gaps 

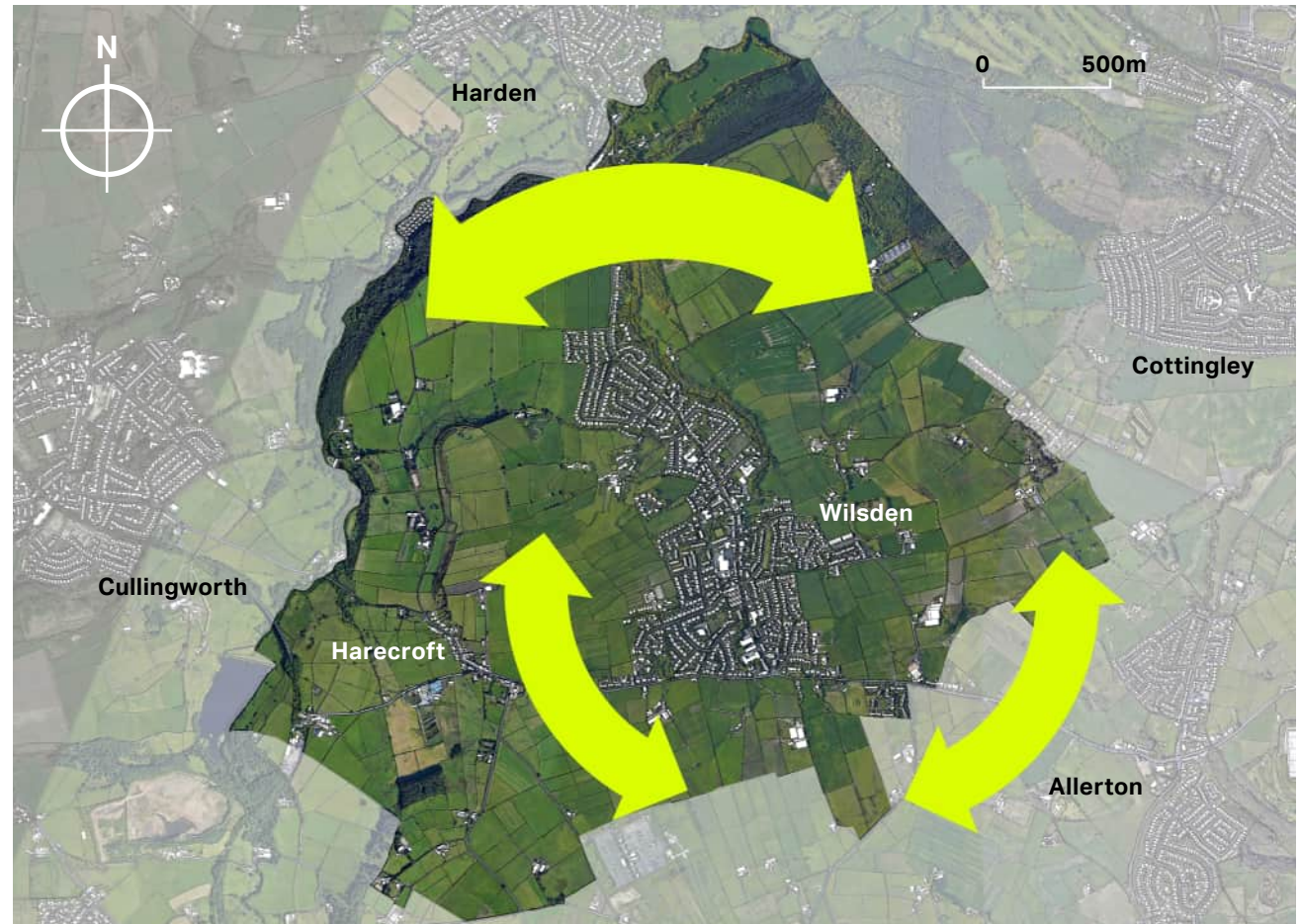

*Village Separation*



## 2B - Backland Development

Backland development (development on land of an existing property) has the potential to cause issues for existing residents including loss of privacy, daylight and parking problems. Proposed backland development should ensure that the spacing requirements set out within code 5A of this document are maintained and that the density, scale and appearance of the development reflects its immediate context and reduces impacts to the amenity of existing properties.

Tandem development is a form of backland development where a new dwelling is placed immediately behind an existing dwelling and served by the same vehicular access. Tandem developments will generally be unacceptable due to the impact on the amenity of the dwelling at the front of the site .

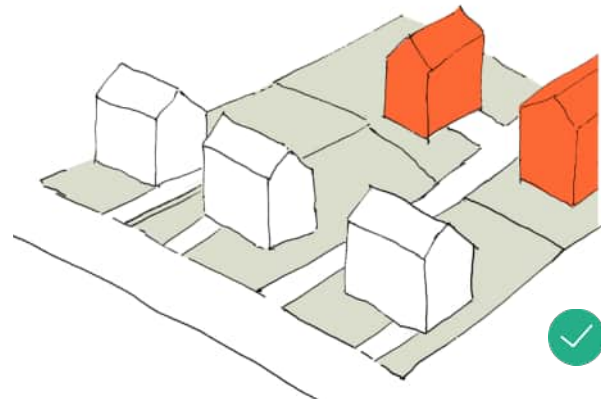

*Backland development*

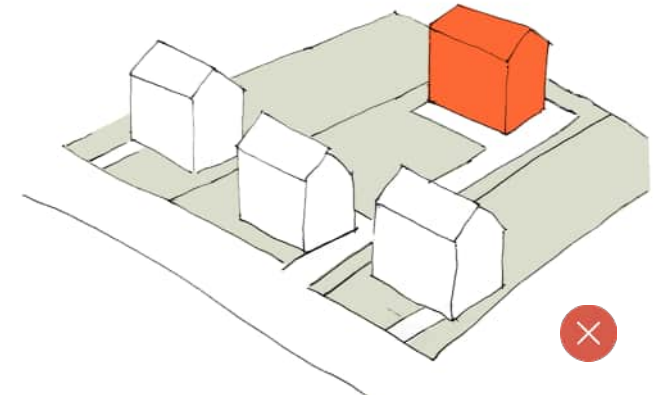

*Tandem development will generally be unacceptable*



## 2C - Views from the Villages

New residential developments should be designed to have a minimal impact on the surrounding landscape setting. Where a development has the potential to obscure existing views and vistas to the surrounding landscape lower building heights should be proposed.

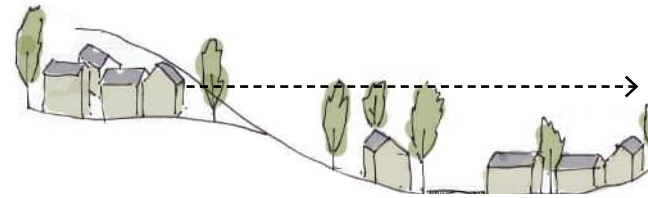

*Views of the surrounding landscape should be protected*

## 2D - Views to the Villages

New residential developments should be well integrated with existing and/or proposed landscaping such as hedgerows and tree planting to provide natural screening and reduce the visual impact of development on the surrounding landscape. New development located on a hillside will be more visible from the surrounding landscape and should provide additional screening through tree planting.

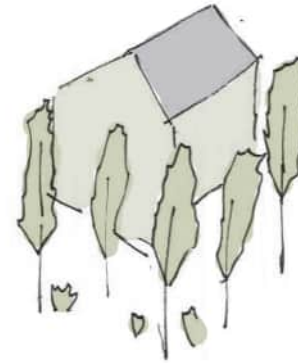

*Views to the villages from the surrounding landscape should be protected by providing natural screening through the use of hedgerows and trees.*

## 2E - Development Spacing

A key characteristic of the Parish is the influence of the surrounding landscape on the streets. Views to the surrounding woodland and hills can be seen from many of the streets in both villages. The protection of this will be key in any future development. Therefore, any future development should ensure that there is sufficient spacing between dwellings to allow the surrounding landscape to be visible from the street.

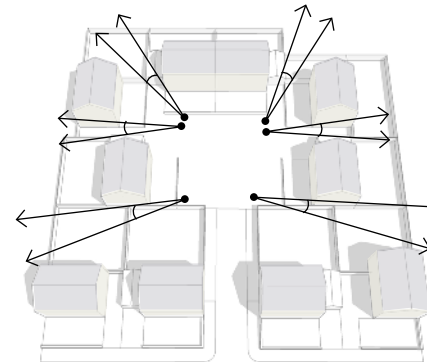

*Spacing between dwellings should retain views to the surrounding landscape*

## 2F - Views to Local Landmarks

New developments should respect the existing shape and rhythm of skylines and new buildings should not obscure views to local landmarks.

## 2G - Edge of Settlement

The most sensitive area to development is the settlement edge, at the interface between developed and rural environments. It is recommended that any development at the settlement edge should be of a lesser density than the rest of the settlement area in order to achieve a soft and graduated transition in to the rural landscape. The density of development will need to be compliance with Core Strategy Policy HO5 (and any successor policy in the Local Plan, when adopted)

Where appropriate, access to the surrounding landscape should be designed in to future development, connecting to the network of existing public rights of way surrounding the villages.

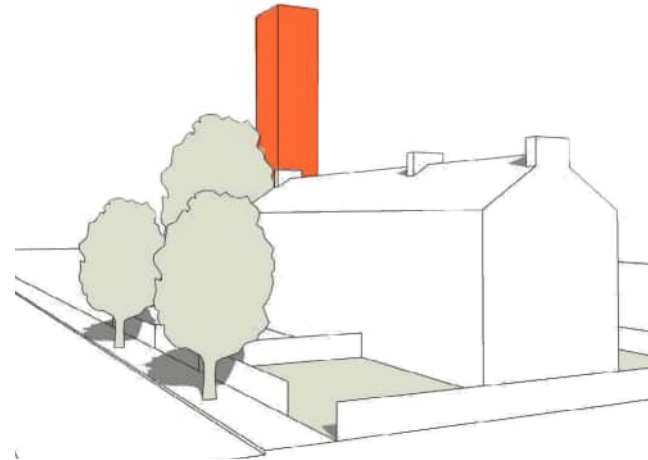

*Views of important landmarks should be protected*

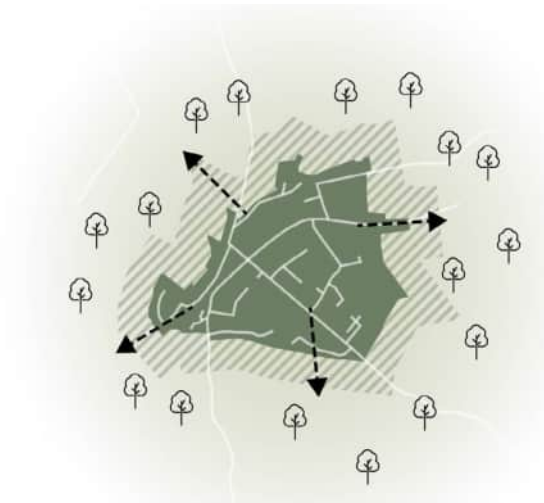

*Development at the settlement edge should have lower densities to achieve a soft transition in to the surrounding landscape*



## 4.6 Code 3 - Building Design

### 3A - Height and Scale

Future development should generally adhere to a maximum height of two storeys. It is acceptable for a dwelling to provide an additional storey within the roof space and use sky lights and/or gable end windows. Taller dwellings may be appropriate where the landscape allows for developments of this scale and important views are not lost as a result.

The scale of future development should generally be informed by adjacent dwellings. Neighbouring properties should be used to create a building envelope for future developments to adhere to.

### 3B - Sensitive Conservation of Historic Buildings

The conversion of historic buildings into residential use should look to preserve and enhance existing heritage features, to maintain the integrity of the original building.

Any new openings (windows and doors) should be positioned carefully to maintain the character and balance of the building and reflect the existing design through use of complementary materials and finishes.

The area around the building should be designed to the same standard as the changes to the building itself. Consider the existing character, the defining features of the local landscape, and any views into the site.

These buildings create the opportunity to provide large single dwellings or can be split into a series of smaller dwellings.

Where converted buildings are extended, care should be taken to ensure that the form of the building is balanced and that any additions, maintain the character and materiality of the existing building.

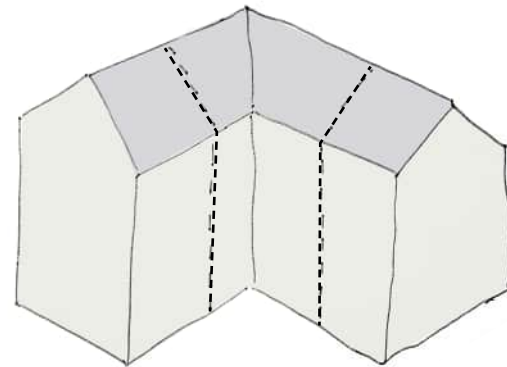
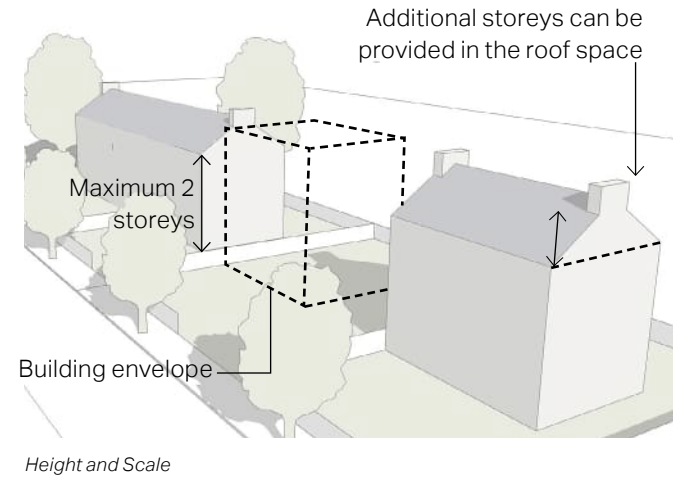

*A large building such as a historic agricultural building or former mill can be split in to smaller dwellings or provide one large dwelling*



*A more recent building responds positively to the scale of existing adjacent dwellings on Main Street*



*Providence mill has been sensitively converted into residential use*



*The Wesleyan Sunday School building has been converted into apartments*



*Lee Farm has been converted into residential use*



### 3C - Materials and Detailing

Informed by the local vernacular, the adjacent diagram illustrates acceptable materials and detailing for future housing developments in Wilsden. Future developments should carefully apply this code to avoid creating a pastiche of the existing local vernacular. Detailing can be interpreted using contemporary methods to avoid this.

More detail on appropriate materials should be sourced from the Wilsden Conservation Area Appraisal.

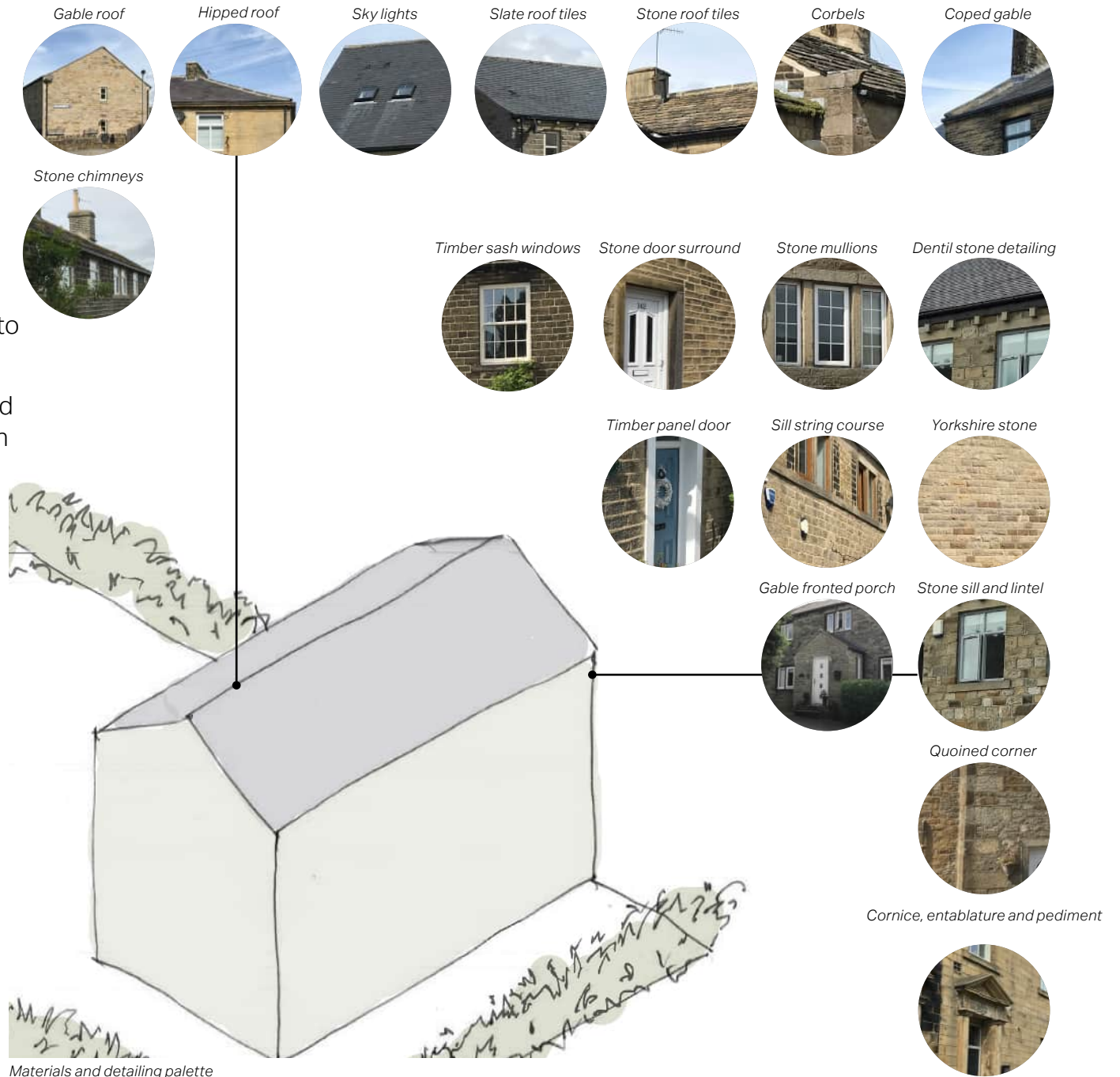

## 4.7 Code 4 - Parking, Gardens and Boundary Treatments

The adjacent diagram illustrates the different ways that parking can be appropriately provided within future housing developments. Parking should be in compliance with the councils parking policy and standards.

### 4A - On-Street Parking

On-street parking is the only parking option for several dwellings within Wilden's historic centre. In order to reduce the visual impact of parked cars on the street, on-street parking as the only means of parking should be avoided in future development.

### 4B - Front of Dwelling Driveway Parking

Parking provided on driveways directly in front of dwellings should be restricted due to the visual impact that cars have on the street. Therefore, a maximum of 2 adjacent dwellings on a street will be permitted to provide parking in this way. Where parking is to be provided at the front of a dwelling, front gardens should be a minimum depth of 6m to allow movement around parked vehicles and also be well screened with hedgerows.

### 4C - Side of Dwelling Driveway Parking

Parking being provided on a driveway to the side of a dwelling should be of sufficient length (5m minimum) so that a car can park behind the frontage line of the dwelling. This will reduce the visual impact that cars will have on the street scene. When parking is provided to the side of a dwelling a minimum front garden depth of 3m should be provided,

### 4D - Garage Parking

Parking being provided in a garage should typically be set back from the frontage line of the dwelling to reduce the visual impact of cars on the street. Garages should also provide sufficient room for cars to park inside them as well as provide some room for storage. The minimum internal dimensions of a garage should be large enough to park a vehicle and allow for movement around a parked car. Garage internal dimensions should therefore be a minimum of 6.5m x 3m. The conversion of garages in to extensions of dwellings will be inappropriate where this would result in cars being parked off the plot of the dwelling. Where this would result in cars being parked within the plot of a dwelling code 4B and/or 4C should be adhered to.

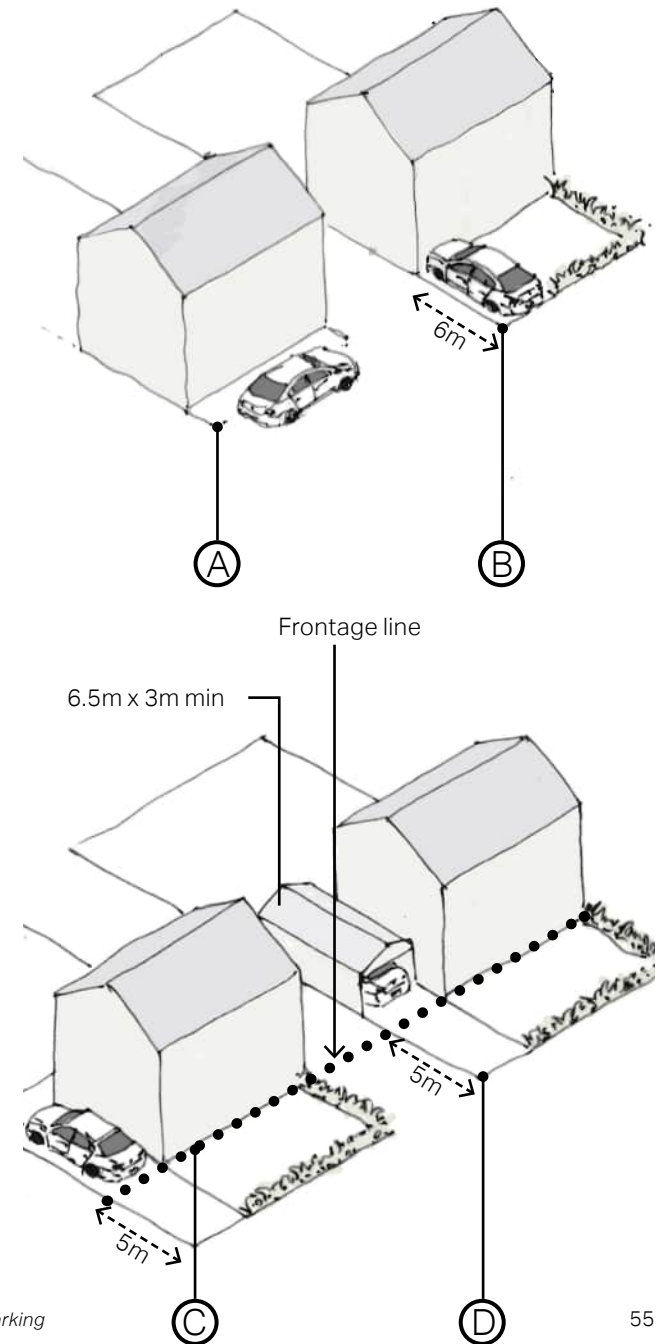



## 4E - Boundary Treatments

Dry-stone walls are of particular importance to the history and distinctive character of the Wilsden area. The construction and retention of dry-stone walls in the local traditional style will be sought in development proposals wherever possible. Development proposals that would result in the removal of, or have an adverse impact on, a natural stone wall will only be supported where it can be demonstrated that the benefits of the development will outweigh the harm caused by the removal of the wall or a replacement dry-stone wall of equivalent value is provided in a suitable location in the Parish (utilising the recalimed materials).

Timber fencing will not be an appropriate boundary treatment in future development proposals.

Where appropriate, front boundaries should respond to the boundaries used within adjacent dwellings to provide continuation of street character. The preferred boundary treatment will be dry stone walls. Other boundary treatments seen around the parish are illustrated below.

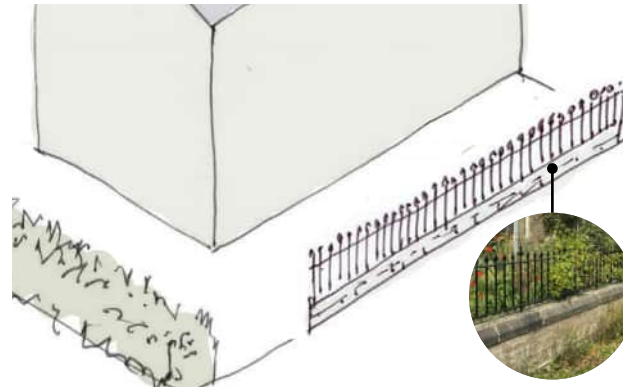

*Low stone wall and railings*

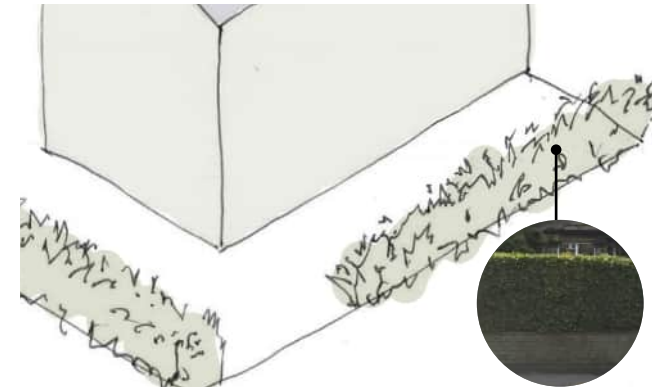

*Stone wall and Hedgerow*



*Dry stone wall*

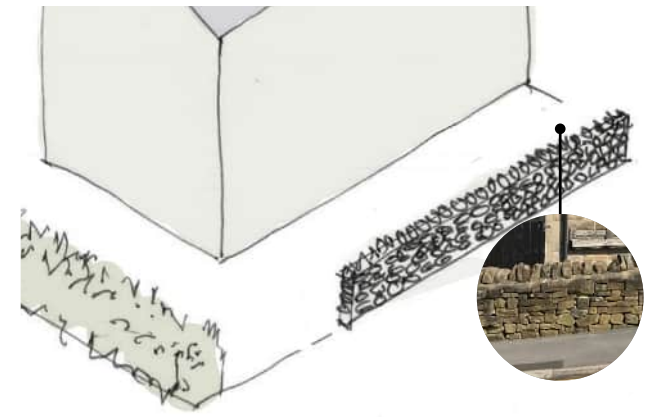

*Dry stone wall*

#### 4F - Back Gardens

Back gardens should be a minimum depth of 10m and provide a minimum area of 50m<sup>2</sup> of usable amenity space. North facing back gardens should exceed 10m in length to ensure sunlight is maximised.

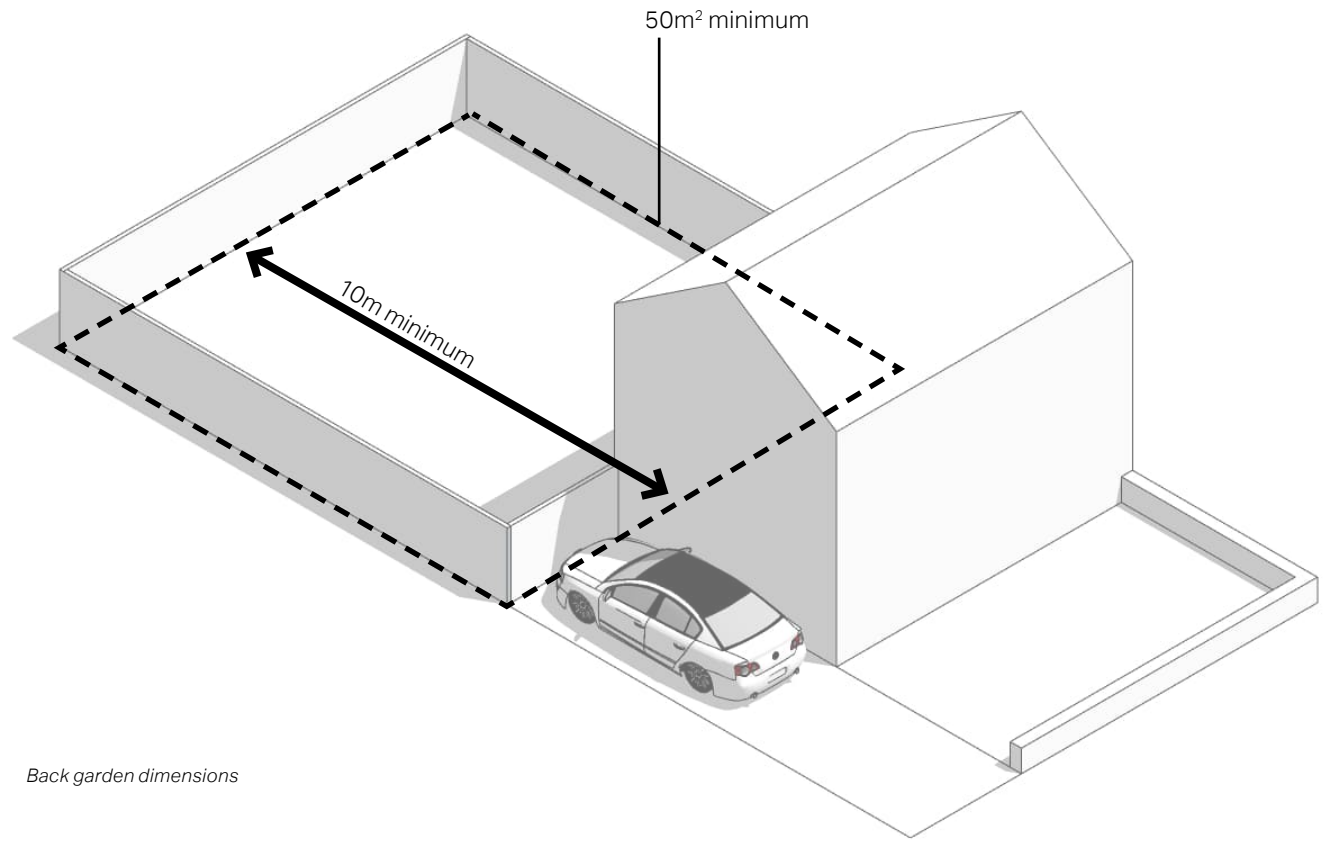

*Back garden dimensions*



## 4.8 Code 5 - Privacy, Space and Natural Surveillance

### 5A - Privacy and Space Between Dwellings

To avoid overlooking of habitable rooms and gardens, typically a minimum distance of 10.5m should be achieved between a habitable room window and a curtilage boundary.

A minimum separation distance of 21m should be achieved between facing windowed rear elevations.

Planted privacy strips can be used to reduce overlooking

Where dwellings with facing elevations are positioned on different levels, the above separation distances should be increased by 2m for every 1m difference in level. Where there is a level difference and distances are increased, the lower dwelling should have the longer garden to compensate for any slopes or retaining structures.

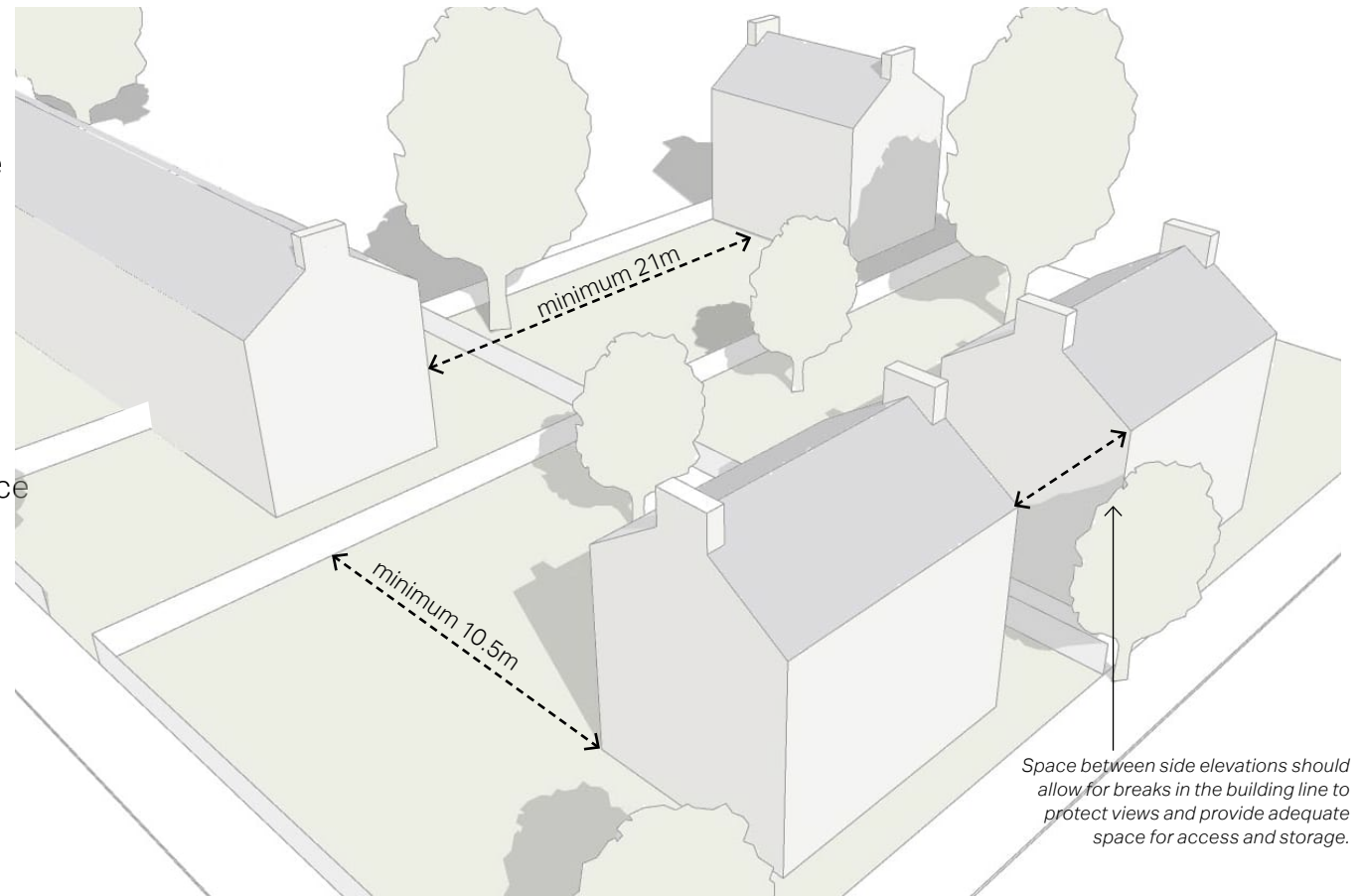

Privacy and space between dwellings

## 5B - Natural Surveillance

In order to provide a sense of security and natural surveillance, the windowed front elevation of a dwelling should face the street where this is in keeping with local character.

There are some examples within the parish of rear boundaries facing the street. Where possible this should be avoided as this has a negative impact on the character of a street and reduces levels of security and natural surveillance. Rear boundaries should back on to other rear boundaries or provide a soft transition in to the natural environment such as at the settlement edge.

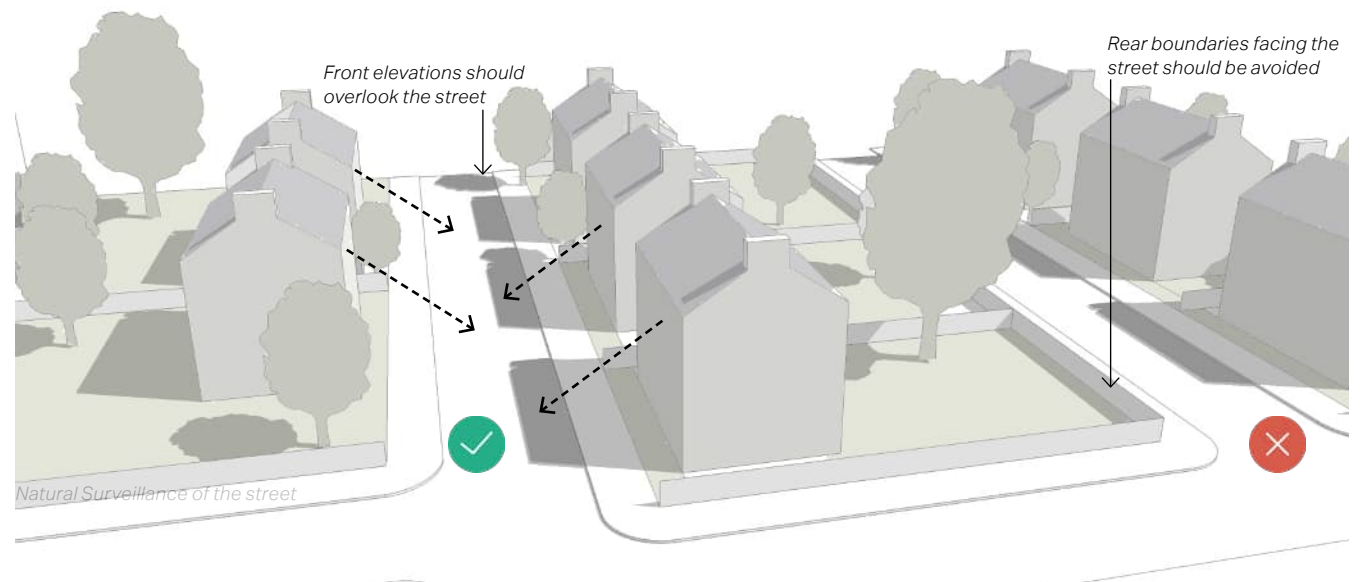

Natural Surveillance





## 5. Site Responses

The following section looks at different site responses within Wilsden. These include a potential development site within the settlement area and an edge of settlement site scenario. Design codes have been applied to each site scenario using high level design principles diagrams.



## 5.1 Possible development site at Crooke Lane (within settlement area)

**Site area:** 0.4ha



**Coding Area:** Historic Character Area & Post-war / Modern Character Areas.

Development on this site should strongly reflect the character of the Historic Character Area.

**Designations:** Site is partially in the Conservation Area but it should be treated as though it is wholly in the Conservation Area.

**Indicative number of dwellings:** 10

A higher housing yield could be achieved on this site using terraced housing.

-  Potential Vehicular access.
-  Potential pedestrian access to improve permeability between Crooke Lane and Wellington Road.
-  Code 4E - Preserve and respond to existing stone wall boundary treatments.
-  Code 1A/2D - Incorporate existing trees within landscaping / gardens of a proposed development.
-  Code 2D/5A - Provide planted green privacy buffer to screen between Wilsden Medical Centre and any proposed development.
-  Code 5A - Consider privacy distances between existing and proposed dwellings.
-  Code 3A - Respond to scale of existing dwellings within context of site.
-  Code 2C - Preserve views from within the site to the surrounding landscape.
-  Code 1A - Consider sun path when designing the orientation of layouts and buildings to allow for passive solar gain and the installation of PV cells.

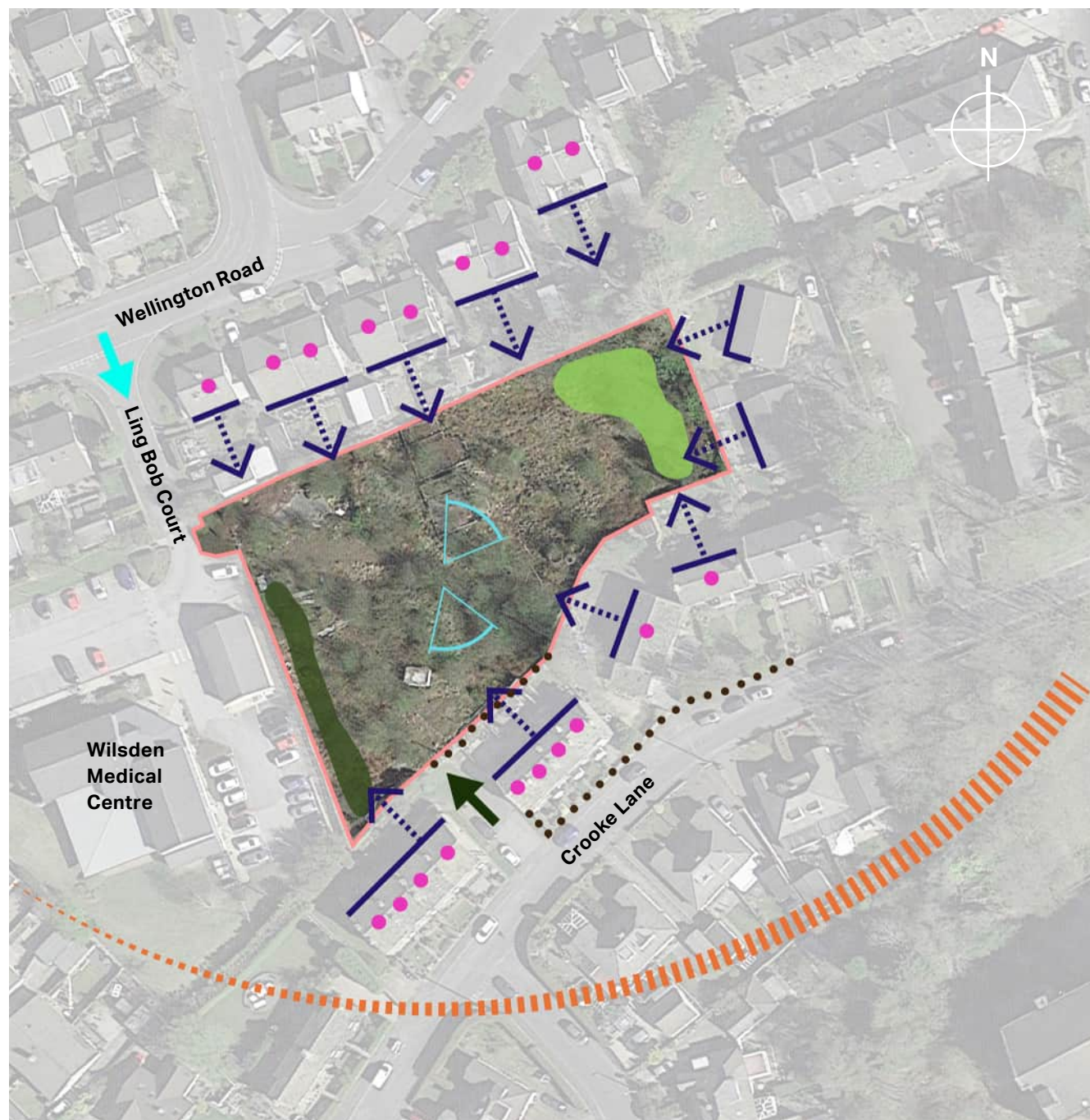

*Crooke Lane Design Principles*















## 5.2 An edge of settlement site scenario

**Site area:** 3ha

**Coding Area:** Rural Surrounding Landscape

**Indicative number of dwellings:** 80

**Designations:** Green Belt

-  Potential site access.
-  Code 2G - Potential to connect pedestrian access to existing Public Right of Way.
-  Public Right of Way.
-  Code 4E - Preserve and respond to existing dry stone wall boundary treatments.
-  Code 4E - Potential to enclose site boundary with drystone wall.
-  Code 1A/2D - Incorporate existing trees within landscaping / gardens of a proposed development.
-  Code 2D/5A - Provide an accessible planted green buffer to soften the transition between any proposed development and the Green Belt. Planting should be an appropriate native species such as Hawthorn or Rowan avoiding the use of Laurel or Laylandii. This edge treatment should form a strong boundary to the village and not provide opportunities for future Green Belt development sites to come forward.
-  Code 5A - Consider privacy distances between existing and proposed dwellings.
-  Code 3A - Respond to scale of existing dwellings within context of site.
-  Code 2C - Preserve views from within the site to the surrounding landscape.
-  Code 1A - Consider sun path when designing the orientation of layouts and buildings to allow for passive solar gain and the installation of PV cells.
-  Code 2G - Use lower densities at the settlement edge to reduce the visual impact on the surrounding landscape/ Green Belt and avoid creating a hard settlement edge. The arrangement of buildings and street pattern in any future proposal should not allow future vehicular access points on to the Green Belt.

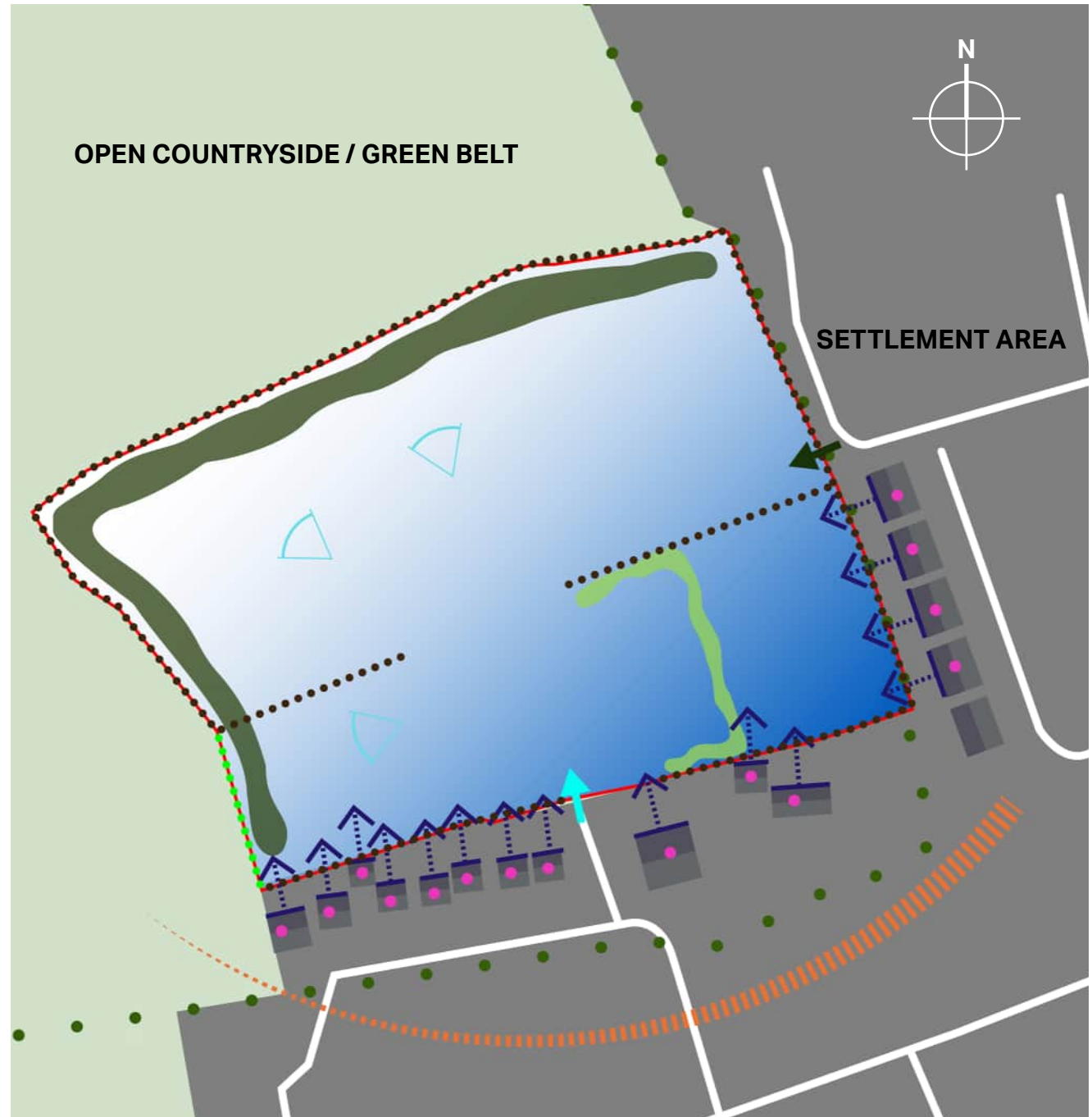

Edge of settlement site scenario design principles

## 6. Next Steps

This document forms part of the evidence base for the Wilsden Neighbourhood Plan and it is recommended that the codes are embedded within the forthcoming plan as policy.

Should any development sites come forward in the Parish through a site selection and allocation process, these could be reviewed through a Site Assessment package that AECOM can offer, the NPSG may also want to consider developing a masterplan for the sites. This will capture and reflect local opinion on appropriate housing densities and layouts as well as provide more certainty for preferred development sites within the Neighbourhood Area.

As well as providing certainty to the local community, the design codes in this document should give more certainty to developers, as they will be able to design a scheme that is reflective of community aspirations, potentially speeding up the planning application process.

As well as using this document, future developers should also make sure that they have observed the guidance in the Department for Levelling Up, Housing and Communities' **National Design Guide**.

Developers should also note that housing developments of any size should strive to achieve carbon neutrality in line with the Government's forthcoming **Future Homes Standard**.

Further standards on residential developments should also be obtained from **Building for a Healthy Life**, a government-endorsed industry standard for well-designed homes and neighbourhoods.



